

# SHERRILL FURNITURE

2024 CATALOG







1823 Sofa  
DC5 Ottoman  
330-975 South Hampton Drawer End Table  
969-450 Addison Cocktail Table

SHERRILL FURNITURE

# American Made Custom Furniture.

Look for these icons indicating available custom options for each Sherrill Furniture item.



## Additional Styles

Looking for a matching item? This icon indicates multiple items are available in a style. Coordinated looks are offered for both wood and upholstery collections.  
\* See Index for List of Additional Styles



## Finish Options

Let your imagination run wild with our hand applied Custom Finish program. You can even mix and match finish combinations. The opportunities are endless.



## Nailhead Trim

Nail trim options are available on many items, so you can pair the perfect nailhead to customize your piece.



## Leather Options

Who can resist the comfort of leather? The hide icon points out frames that can also be covered in any of our luxurious leathers.



## Swivel Option

A swivel base adds extra functionality to any room in your home allowing more sitting, viewing and interaction opportunities.



## Swivel Rocker

Select seating styles offer optional glider/rocker motion with full 360° smooth swivel turning ability.



SHERRILL FURNITURE

**Sherrill Furniture has become synonymous with beautiful hand-crafted furniture. Every sofa, chair, chaise and ottoman is lovingly made in Hickory, North Carolina, USA.**





DC362 Sofa  
243-850 Bay Harbor Cocktail Table



# Inside:

The Sherrill Way .....	10
Craftsmanship.....	11
SherrillFurniture.com .....	12
Sofas & Loveseats.....	20
41 Series .....	72
42 Series .....	78
43 Series .....	82
44 Series .....	86
45 Series .....	90
46 Series .....	94
9600/9700-Design Your Own.....	98
Sherrill Your Way .....	120
2 Series-Design Choices.....	126
6 Series-Design Your Own.....	138
Design Classics.....	150
Chairs & Ottomans.....	172
Swivel Chairs .....	198
Motion Swivel Chairs .....	204
Wing Chairs .....	208
Carved Chairs .....	214
Dining Chairs .....	218
Ottomans & Benches .....	222
Nail Trim Options .....	238
Custom Line Wood Finishes.....	242
Seat Cushions.....	247
Sleeper Mechanism & Mattress Specifications.....	248
Sherrill Construction .....	250
Numeric Index.....	258
Visual Index .....	274





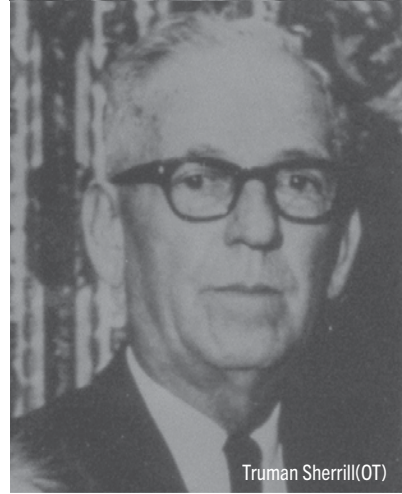

Truman Sherrill(OT)



Harold Whittemore "Buddy" Sherrill



Charles Sherrill



# From Modest Beginnings

“It was never just about the money. Good companies are all about the people, and the families who make this industry possible.”

—CHARLES SHERRILL

## 1920

As World War 1 ends, a young Oscar Truman Sherrill (OT) returns home from US Army Infantry duty and begins working in the casegoods furniture industry. By the 1930s, OT Sherrill becomes one of the first trained upholstery craftsmen in Hickory, NC employing manufacturing techniques taught by master craftsmen from the Michigan furniture industry.

## 1940

OT Sherrill and two office employees begin building upholstery in a leased building near downtown Hickory.

## 1943

Buddy Sherrill graduated from Hickory High School and was drafted into the Army Air Corps aviation cadet program.

## 1945

Sherrill Furniture Company incorporated by OT Sherrill with a goal to provide a good living for his family. World War 2 ends before Buddy Sherrill's aviation training and deployment to combat.

## 1950

Buddy Sherrill graduates University of South Carolina with a degree in business administration and retail. Returns home to join the family business that is beginning to thrive as department stores and the post war home boom begins to take off.

## 1960

Sherrill Furniture Company grows rapidly in leading department stores and furniture stores around the country. OT and Buddy Sherrill gain a larger vision of providing for their family and creating good jobs for the community they live in.

## 1973

Sherrill Furniture® is rated #1 in the Medium Range furniture segment.

## 1975

Earl Poole is hired away from luxury furniture maker Henredon to join Sherrill Furniture and establish the company as a high-end, luxury furniture resource.

## 1978

Sherrill Furniture Company acquires the MotionCraft® brand and manufacturing plant in Morganton, NC.

## 1979

Sherrill Furniture Company purchases Carolina Tables of Hickory (CTH) and establishes the CTH Sherrill Occasional® casegoods business.

## 1984

Sherrill Furniture Company acquires Precedent®, a small scale modern chair specialist, and their manufacturing plant in Newton, NC. Precedent founder Ed Harmon stayed on with the company and continues in a leading role with product design through today.

## 1984

The single-story Sherrill Furniture showroom was built at 315 Fred Alexander Place in High Point, NC.

## 1986

Charles Sherrill joins the family business full time and begins learning furniture design and quality manufacturing from his father.

## 1988

Sherrill Furniture launches the Whittemore Sherrill® line of leather upholstery furniture.

## 1997

Sherrill Furniture Company acquires Hickory White Company that is in financial distress, as low cost imported wood furniture from China decimates the industry. Buddy Sherrill's goal was to keep the business running and the people there employed in order to preserve the community of skilled casegoods craftspeople in the Catawba Valley region.

## 2002

Sherrill Furniture showroom undergoes major expansion adding-on a 2nd and 3rd floor to create over 100,000 square feet of space.

## 2007

The Great Recession hits. Sherrill Furniture Company is forced to trim some jobs and overhead, but does whatever it takes to keep factories humming and the craftspeople who make quality casegoods and upholstery furniture employed.

## 2009

Lillian August® for Hickory White partnership established to produce a full line of furniture designed by Lillian August.

## 2012

Mr. & Mrs. Howard® for Sherrill Furniture partnership established to produce a full line of furniture designed by Jim & Phoebe Howard.

## 2019

Lemieux et Cie™ partnership established with Precedent factory to produce a full line of furniture by designer Christiane Lemieux.

## 2022

Sherrill Furniture Company invests in a custom upholstery plant, bringing 90 new jobs to Conover, NC. Sherrill Furniture Company completes major renovation of the showroom building with all brands displayed under one roof.

## 2023 (& beyond)

Sherrill Furniture Company launches the most technically advanced B2B ecommerce portal in furniture. New platform is able to configure, price and quote the more than 4.7 trillion custom furniture combinations the company offers today.



1940s - 1950s



mid-1950s - 1960s



1960s - 1970s



mid 1970s - 1980s



1980s - 2022



present





# The Sherrill Way

The process of hand-crafting our furniture uses traditional methods passed down through generations alongside the best of modern techniques.

With over 75 years of experience, Sherrill is your best choice to create upholstered furniture for your home. With skill and care, we blend traditional American hand craftsmanship such as 8-way hand tied springs with modern manufacturing methods. The result is unparalleled custom-made upholstery to fit almost any need. Our styling follows those same principles by combining timeless design elements with exciting contemporary touches to create one-of-a kind upholstery that you'll treasure for years to come. From traditional to contemporary, every piece is handcrafted to exact specifications by skilled North Carolina craftsman. So enjoy! We thank you for placing your trust and desire for a beautiful home in our hands and know that we are proud to represent your impeccable taste.



## Six Points to Custom-Crafted Perfection

With skill and care, we blend traditional American hand craftsmanship with modern manufacturing methods. The result is unparalleled custom-made upholstery to fit almost any need and made right here in Hickory, North Carolina USA

### The Finest Fabrics

*At Sherrill, we partner with the most respected fabric mills in the industry to offer you an amazing assortment of upholstery fabrics for your home. Our skilled craftspeople take pride in the fine tailoring details that set us apart.*



### Custom Line Finishes

*All Sherrill finishes are now available and interchangeable on any Sherrill custom line or carved chair, offering a multitude of finishes. Of course, each finish is hand-applied by the most skilled artisans in Hickory, North Carolina.*



### Cushions

*Sherrill offers 6 different cushion types designed to address alternative firmness as well as levels of tailoring. Whether you are looking for soft and relaxed or firm and tailored, we have a solution that meets your comfort level and exceeds expectations.*



### Nail Head Trim

*The perfect way to accent your Sherrill frame is with our nail head trim options. They range from Vintage to Natural to Polished Nickel. With an assortment of sizes, finishes, and spacing to choose from, it's easy to create a unique look. Each nail is hand-applied by the our talented craftspeople.*



### Custom Throw Pillows

*Custom throw pillows are one of a designer's favorite ways to create a unique look. Every Sherrill throw pillow is filled, sewn, and upholstered in our North Carolina factory. We keep your comfort and style at the forefront of everything we do.*

### Welting and Trim

*Take advantage of Sherrill's amazing attention to detail by specifying welting and trim. This is a great opportunity to add the final touches to your piece and create a statement piece that is all your own.*

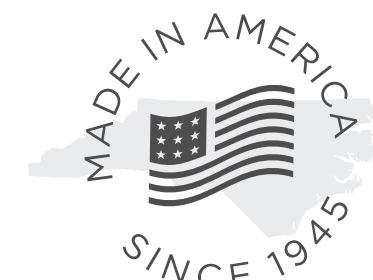





# SherrillFurniture.com From Start to Finish

Put Sherrill's custom options to work for you. Fabrics, finishes, trims, construction techniques...whatever you can dream up, we can help create. Built from the best, made in the USA. The result is unparalleled custom-made upholstery.

## Design Online

Select fabrics, finishes, and trims for any Sherrill frame with the click of your mouse. See the results instantly.

## Download Custom Order Sheets

We make ordering any of our custom programs easy with downloadable order sheets that are ready to print, complete, and order.

## Learn More About Us

Did you know that every Sherrill upholstery item is crafted in our North Carolina facility? Learn more about our capabilities and history.

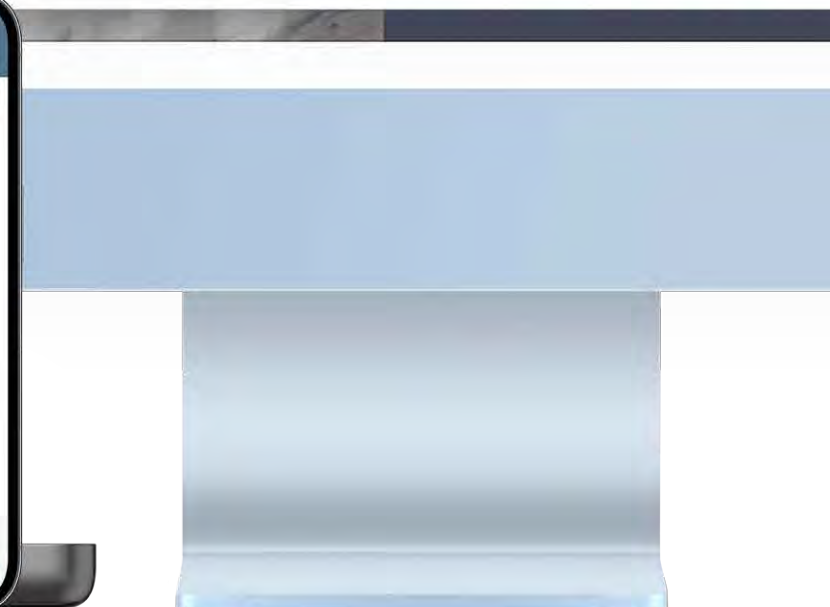
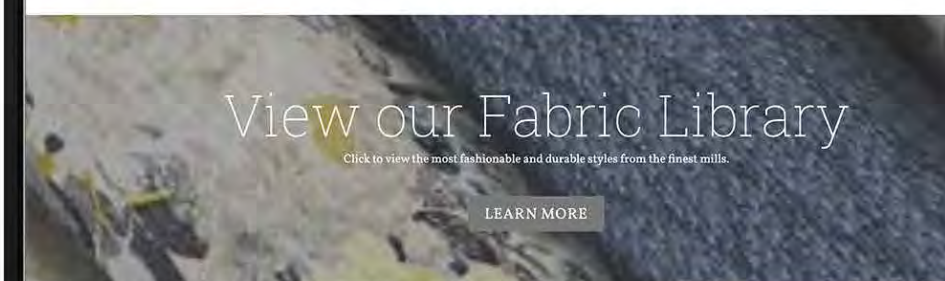
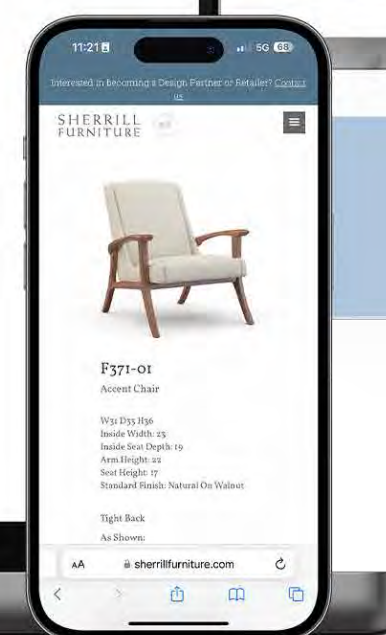
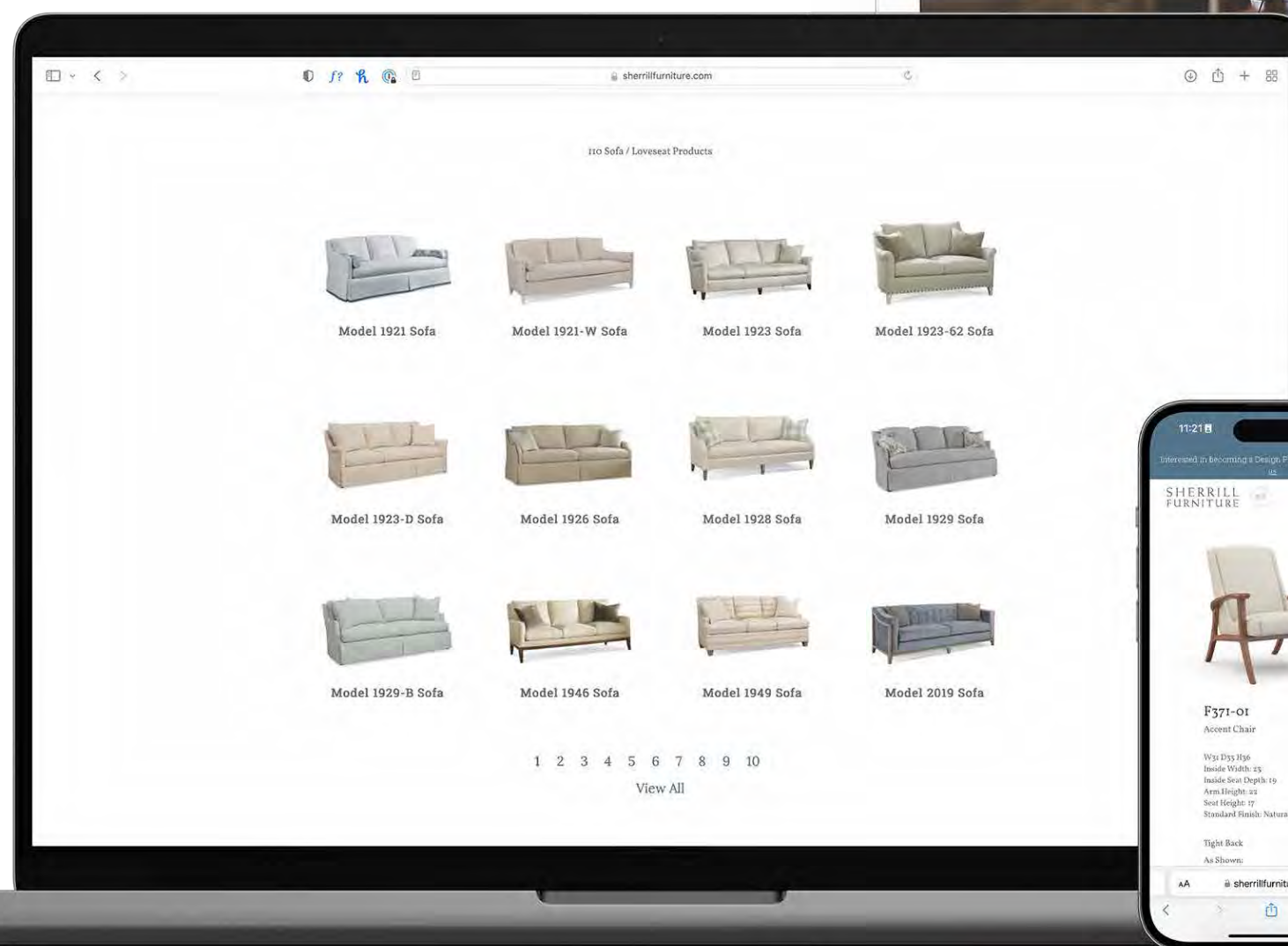
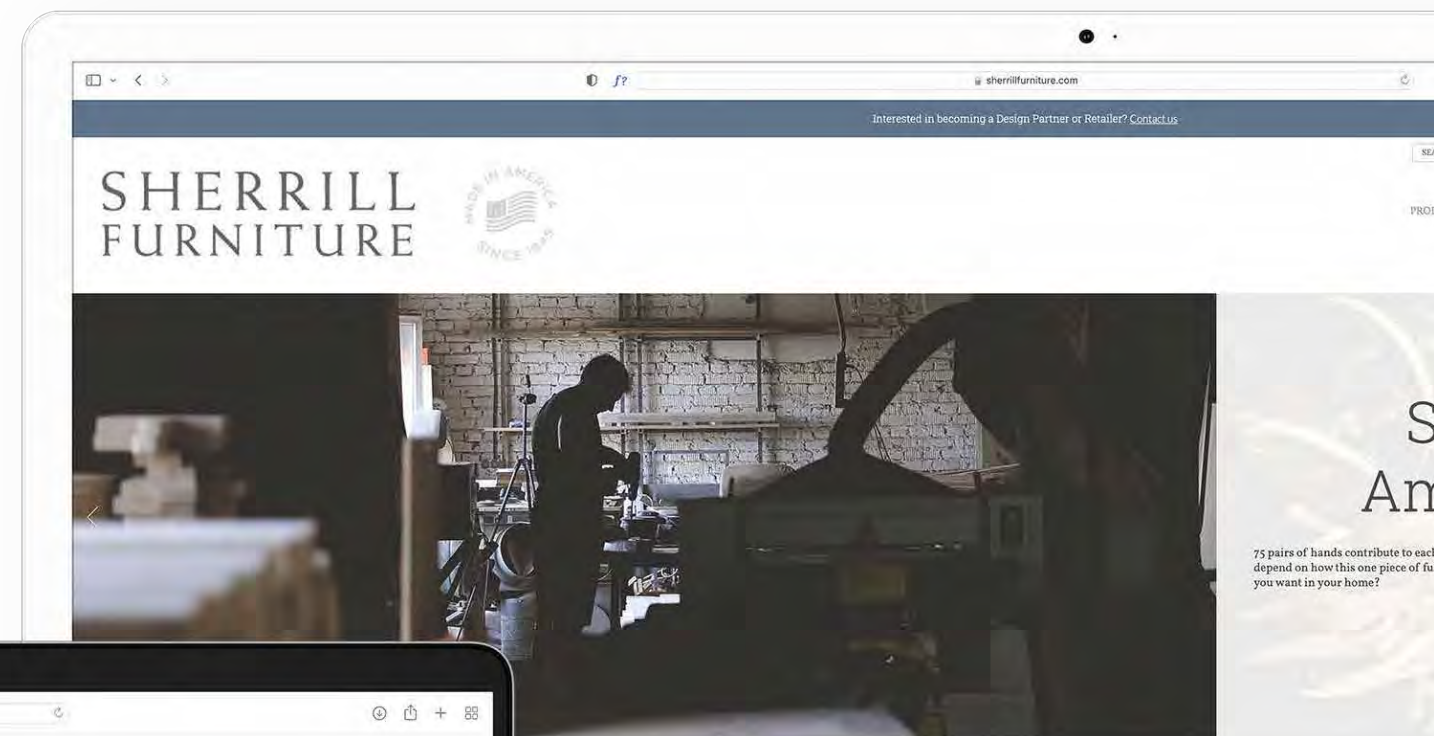





# Skirted or Exposed Leg

Have it your way. Traditional or transitional. You have the option of adding or omitting skirts on most frames. You can really change the personality of your chair or sofa with this option. The matching chair and sofa in the photo to the right display exposed legs, giving this room a fresh feel. See above for more options. See price list for upcharge

All frames are standard as shown unless otherwise noted. To add or omit a skirt from a frame you must specify this option when ordering.

NS = "No Skirt" OPTION

F1735-03 Sofa  
969-450 Addison Cocktail Table  
246-900 Dawson Chairside Table



**3066-3 With Skirt**  
(standard)



**3066-3 NS = "No Skirt" Option**  
(Must specify this option when ordering)



**1529-1 With Skirt**  
(standard)



**1529-1 NS = "No Skirt" Option**  
(Must specify this option when ordering)





# Small Scale Sofas, Loveseats

Got a space problem? Sherrill has beautiful solutions. We'll help you fill those vexing nooks. Choose from traditional skirted styles with shape to sleek profile frames with tastefully exposed raised legs and thin arms. Perhaps you have a couple of nooks? Order in pairs and fill up the room.



## *The Sherrill Way* Scale

*Selecting the perfectly scaled sofa to your home is of utmost importance. Thankfully, Sherrill offers every size. From small scale sofas, settees and loveseats, to standard scale sofas and chairs, to overscaled styles and sectionals.*



1634 Chair  
2212-L Sofa  
968-345 Kinsey Hall Chest  
VMA-065 Mia Accent Table





7157-33 Sleep Sofa  
241-990 Oyster Bay Cabinet  
968-249 Diego Round End Table

# Sofas, Sleeper Sofas & Loveseats

Sleeper sofas and loveseats are a great solution for extra overnight guests. And with the best mechanisms and mattresses in the industry, your guest will enjoy a good night's sleep. Kingsdown Air Dream mattresses are available for sofas in Queen size (60"x73") and for loveseats in Twin size (40"x73").

*Leggett & Platt*  
INCORPORATED

*Air Dream*™ Ultra  
Sofa Sleeper System  
Air Over Coil Technology®

**KINGSDOWN**®  
HANDCRAFTED MATTRESSES SINCE 1904







# Sofas & Loveseats

Every Sherrill sofa and loveseat is designed and crafted to last generations. Our North Carolina skilled craftspeople take pride in creating each piece knowing that it will be cherished for years to come.



## ***The Sherrill Way*** 8-Way Hand-Tied

*The eight-way hand-tied system with interlaced web bottom is indicative of high quality furniture and traditionally the best known technique for insuring long lasting comfort. Our craftspeople have passed down this technique from generation to generation*



3164-4 Sofa  
1015-1 Chair

Casegoods in photo are discontinued.



DC5 Bench  
3061-3 Sofa  
SW DC992 Chair  
245-930 Fox Hollow Round Lamp Table





**F1557-03 Sofa**

72w 38D 38H  
 Inside: 64w 21D 19H  
 Arm Height: 24 Seat Height: 19  
 Semi-Attached Back  
 Standard Throw Pillows: Two 21" x 21"  
 Standard Nail: #1-FN  
 Finish Shown: Carob Brown

**F1568-03 Sofa**

92w 35D 38H  
 Inside: 77w 20D 18H  
 Arm Height: 26 Seat Height: 20  
 Semi-Attached Back  
 Standard Throw Pillows: Two 21" x 21"  
 Finish Shown: Carob Brown

**F1557-06 Sofa**

86w 38D 38H  
 Inside: 78w 21D 19H  
 Arm Height: 24 Seat Height: 19  
 Semi-Attached Back  
 Standard Throw Pillows: Two 21" x 21"  
 Standard Nail: #1-FN  
 Finish Shown: Carob Brown

**F1660-03 Sofa**

87w 35D 36H  
 Inside: 76w 21D 17H  
 Arm Height: 23 Seat Height: 19  
 Loose Pillow Back  
 Standard Throw Pillows: Two 21" x 21"  
 Available In Natural Walnut Only

**F1558-03 Sofa**

92w 35D 38H  
 Inside: 77w 20D 18H  
 Arm Height: 26 Seat Height: 20  
 Semi-Attached Back  
 Standard Throw Pillows: Two 21" x 21"  
 Finish Shown: Carob Brown

**F1735-03 Sofa**

89w 38D 40H  
 Inside: 78w 21D 21H  
 Arm Height: 24 Seat Height: 19  
 Semi-Attached Back  
 Standard Throw Pillows: Two 21" x 21"  
 Standard Nails: #1-FN & #3-FN  
 Finish Shown: Carob Brown





**1823 Sofa**

91w 39D 37H  
 Inside: 81w 22D 18H  
 Arm Height: 23 Seat Height: 19  
 Loose Pillow Back  
 Standard Throw Pillows: Two 21" x 21"  
 Standard With Recessed Wood Legs

**1921 Sofa**

88w 40D 36H  
 Inside: 76w 22D 16H  
 Arm Height: 25 Seat Height: 20  
 Loose Pillow Back  
 Standard Throw Pillows: Two 6"x  
 22" Cylinder Pillows  
 Standard With Dressmaker Skirt

**1829 Sofa**

88w 38D 36H  
 Inside: 77w 21D 17H  
 Arm Height: 25 Seat Height: 19  
 Loose Pillow Back  
 Standard Throw Pillows: Two 21" x 21"  
 Standard With Recessed Wood Legs

**1921-W Sofa**

88w 40D 36H  
 Inside: 76w 22D 16H  
 Arm Height: 20 Seat Height: 20  
 Loose Pillow Back  
 Standard Throw Pillows: Two 6"x  
 22" Cylinder Pillows  
 Finish Shown: Linen

**1904 Sofa**

85w 34D 38H  
 Inside: 76w 19D 19H  
 Arm Height: 26 Seat Height: 19  
 Loose Pillow Back  
 Standard Throw Pillows: Two 21" x 21"  
 Standard With Dressmaker Skirt

**1923 Sofa**

91w 39D 37H  
 Inside: 81w 21D 18H  
 Arm Height: 25 Seat Height: 19  
 Loose Pillow Back  
 Standard Throw Pillows:  
 Two 21" x 21"  
 Finish Shown: Carob Brown







1921 Sofa

3317 Chair

6027 Ottoman

MH21323 Edith Side Table

MH26331-90 Verner Console

965-126N Trifecta Round Cocktail Tab



**1923-62 Loveseat**

62w 39D 37H  
 Inside: 52w 21D 18H  
 Arm Height: 25 Seat Height: 19  
 Loose Pillow Back  
 Standard Throw Pillows: Two 21" x 21"

**1923-D Sofa**

91w 39D 37H  
 Inside: 80w 21D 18H  
 Arm Height: 25 Seat Height: 19  
 Loose Pillow Back  
 Standard Throw Pillows: Two 21" x 21"  
 Standard With Dressmaker Skirt

**1923-62D Loveseat**

62w 39D 37H  
 Inside: 52w 21D 18H  
 Arm Height: 25 Seat Height: 19  
 Loose Pillow Back  
 Standard Throw Pillows: Two 21" x 21"  
 Standard With Dressmaker Skirt

**1926 Sofa**

85w 34D 38H  
 Inside: 78w 21D 19H  
 Arm Height: 25 Seat Height: 19  
 Loose Pillow Back  
 Shown With Optional Nail: #1-BZ  
 Standard Nail: #1-FN  
 Standard Throw Pillows: Two 21" x 21"  
 Standard With Dressmaker Skirt

**1928 Sofa**

85w 35D 38H  
 Inside: 77w 21D 19H  
 Arm Height: 25 Seat Height: 19  
 Loose Pillow Back  
 Standard Throw Pillows: Two 21" x 21"  
 Finish Shown: Carob Brown

**1929 Sofa**

88w 38D 36H  
 Inside: 80w 21D 17H  
 Arm Height: 25 Seat Height: 19  
 Loose Pillow Back  
 Standard Throw Pillows: Two 21" x 21"  
 Standard With Dressmaker Skirt





1923 Sofa  
116-01 Chair  
223-940 Corbel Lamp Table  
969-450 Addison Cocktail Table





**1929-B Sofa**

88w 38d 36h  
 Inside: 80w 21d 17h  
 Arm Height: 25 Seat Height: 19  
 Loose Pillow Back  
 Standard Throw Pillows: Two 21" x 21"  
 Standard With Dressmaker Skirt

**1949 Sofa**

81w 38d 38h  
 Inside: 72w 23d 18h  
 Arm Height: 25 Seat Height: 20  
 Loose Pillow Back  
 Standard Throw Pillows: Two 21" x 21"  
 Finish Shown: Carob Brown

**2019 Sofa**

100w 37d 34h  
 Inside: 84w 23d 15h  
 Arm Height: 30 Seat Height: 19  
 Tight Tufted Back  
 Standard Throw Pillows: Two 21" x 21"  
 Finish Shown: Carob Brown

**2120 Sofa**

93w 37d 33h  
 Inside: 77w 23d 13h  
 Arm Height: 33 Seat Height: 20  
 Tight Tufted Back  
 Standard Throw Pillows: Two 21" x 21"  
 Standard With Brass Ferrules  
 Finish Shown: Carob Brown

**2126-B Sofa**

94w 41d 37h  
 Inside: 78w 24d 18h  
 Arm Height: 27 Seat Height: 19  
 Loose Pillow Back  
 Standard Throw Pillows:  
 Two 21" x 21"  
 Two 16" x 18"  
 Standard Nail: #1-P  
 Standard With Silver Ferrules  
 Finish Shown: Carob Brown

**2212L Sofa**

72w 37d 35h  
 Inside: 60w 21d 16h  
 Arm Height: 29 Seat Height: 19  
 Crescent Front  
 Loose Pillow Back  
 Standard Throw Pillows:  
 Two 12" x 22" Arm Bolsters  
 Standard With Kick Pleat Skirt





### 2224-87 Sofa

87w 39d 41h  
Inside: 74w 22d 22h  
Arm Height: 27 Seat Height: 19  
Loose Pillow Back  
Standard With Two 21" Throw Pillows  
Finish Shown: Carob Brown



Also Available:

### 2224-77 Sofa Two Cushion

77w 39d 41h

### 2224-67 Loveseat Two Cushion

67w 39d 41h



1315 Chair  
2224-87 Sofa  
VMA-120 Mabel Accent Table  
VMA-302 Flora Cocktail Table

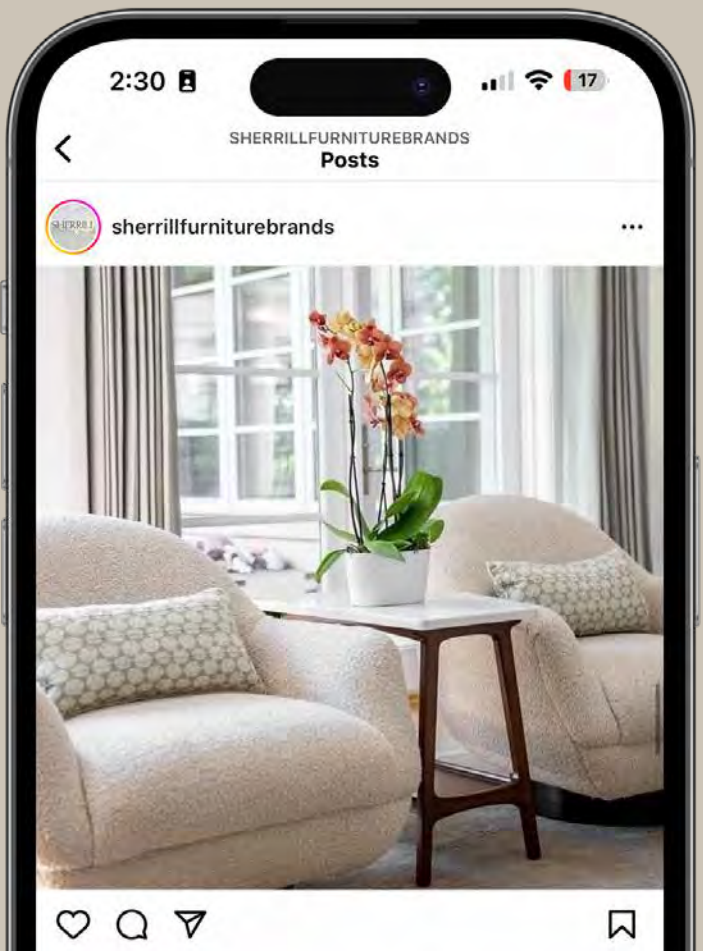

To Stay Up To Date On All Things Sherrill Furniture, Follow Us On Instagram!

@SherrillFurnitureBrands





**2225-60 Loveseat**

60w 35D 35H  
 Inside: 44w 21D 16H  
 Arm Height: 24 Seat Height: 19  
 Loose Pillow Back  
 Standard Throw Pillows: Two 21" x 21"  
 Standard With Dressmaker Skirt

**2225-72 Sofa**

72w 35D 35H  
 Inside: 56w 21D 16H  
 Arm Height: 24 Seat Height: 19  
 Loose Pillow Back  
 Standard Throw Pillows: Two 21" x 21"  
 Standard With Dressmaker Skirt

**2225-78 Sofa**

78w 35D 35H  
 Inside: 62w 21D 16H  
 Arm Height: 24 Seat Height: 19  
 Loose Pillow Back  
 Standard Throw Pillows: Two 21" x 21"  
 Standard With Dressmaker Skirt

**2225-84 Sofa**

84w 35D 35H  
 Inside: 68w 21D 16H  
 Arm Height: 24 Seat Height: 19  
 Loose Pillow Back  
 Standard Throw Pillows:  
 Two 21" x 21"  
 Standard With Dressmaker Skirt

**2226 Sofa**

88w 42D 41H  
 Inside: 75w 20D 22H  
 Arm Height: 26 Seat Height: 19  
 Seat Depth Without Throw Pillows: 24  
 Crescent Front  
 Tight Back  
 Standard Throw Pillows:  
 Four Large: 24" x 24"  
 One Kidney: 13" x 26"  
 Standard With Kick Pleat Skirt

**2230 Sofa**

98w 46D 38H  
 Inside: 83w 21D 19H  
 Arm Height: 26 Seat Height: 19  
 Crescent Front  
 Loose Pillow Back  
 Standard Throw Pillows: Two 20" x 24"  
 Standard With Dressmaker Skirt





### 2232 Sofa

99w 44d 41h  
 Inside: 89w 21d 21h  
 Arm Height: 27 Seat Height: 20  
 Seat Depth Without Throw Pillows: 26  
 Loose Pillow Back  
 Standard Throw Pillows:  
 Two Large 19" x 22"  
 Two Medium 19" x 19"  
 One Kidney 14" x 21"  
 Standard Nail: #4-N Spaced  
 Finish Shown: Carob Brown



### 2235-87 Sofa

87w 41d 38h  
 Inside: 74w 22d 22h  
 Arm Height: 25 Seat Height: 19  
 Loose Pillow Back  
 Standard Throw Pillows: Two 21" x 21"  
 Standard With Dressmaker Skirt



Also Available:

### 2235-67 2-Cushion Loveseat

67w 41d 38h



### 2235-77 3-Cushion Sofa

77w 41d 38h



### 2250 Sofa

90w 40d 40h  
 Inside: 80w 20d 21h  
 Arm Height: 24 Seat Height: 19  
 Loose Pillow Back  
 Standard Throw Pillows:  
 Two Large 24" x 24"  
 Two Medium 22" x 20"  
 Finish Shown: Carob Brown



2232 Sofa



**2250-B Sofa**

90w 40d 40h  
 Inside: 80w 20d 21h  
 Arm Height: 24 Seat Height: 19  
 Loose Pillow Back  
 Standard Throw Pillows:  
 Two Large 24" x 24"  
 Two Medium 22" x 20"  
 Finish Shown: Carob Brown

**2361 Sofa**

89w 40d 38h  
 Inside: 73w 23d 19h  
 Arm Height: 28 Seat Height: 19  
 Loose Pillow Back  
 Standard Throw Pillows: Three 21" x 21"  
 Standard Nail: #1-BZ, 3-BZ Spaced  
 Finish Shown: Carob Brown

**2368 Sofa**

95w 42d 39h  
 Inside: 85w 24d 19h  
 Arm Height: 24 Seat Height: 20  
 Loose Pillow Back  
 Standard Throw Pillows:  
 Two Large 17" x 21"  
 Two Medium 16" x 21"  
 Standard Nail: #2-N  
 Finish Shown: Carob Brown

**3061-2 Loveseat**

62w 38d 37h  
 Inside: 43w 22d 18h  
 Arm Height: 24 Seat Height: 19  
 Semi-Attached Backs  
 Standard Throw Pillows: Two 21" x 21"  
 Standard With Kick Pleat Skirt



Also Available:

**7061-22 Sleep Loveseat**

65w 38d 37h

Note: For open sleeper dimensions, add approximately 55 inches from front of arm.



**3061-3 NS "No Skirt"**  
 Option Available

**3061-3 Sofa**

84w 38d 37h  
 Inside: 65w 22d 18h  
 Arm Height: 26 Seat Height: 19  
 Semi-Attached Backs  
 Standard Throw Pillows: Two 21" x 21"  
 Standard With Kick Pleat Skirt



Also Available:

**7061-33 Sleep Sofa**

87w 38d 37h

Note: For open sleeper dimensions, add approximately 55 inches from front of arm.

**3063-3 Sofa**

75w 35d 37h  
 Inside: 61w 21d 19h  
 Arm Height: 27 Seat Height: 18  
 Loose Pillow Back  
 Standard Throw Pillows: Two 21" x 21"  
 Shown With Optional Nail: #1-FN  
 Standard Without Nails  
 Finish Shown: Carob Brown



Also Available:

**7063-33 Sleep Sofa**

80w 35d 37h

Note: For open sleeper dimensions, add approximately 55 inches from front of arm.





### 3066-2 Loveseat

62w 38d 37h  
 Inside: 44w 22d 18h  
 Arm Height: 26 Seat Height: 19  
 Loose Pillow Back  
 Standard Throw Pillows: Two 21" x 21"  
 Standard With Kick Pleat Skirt



Also Available:

### 7066-22 Sleep Loveseat

65w 38d 37h  
 Note: For open sleeper dimensions, add approximately 55 inches from front of arm.



### 3066-3 Sofa

84w 38d 37h  
 Inside: 66w 22d 18h  
 Arm Height: 26 Seat Height: 19  
 Loose Pillow Back  
 Standard Throw Pillows: Two 21" x 21"  
 Standard With Kick Pleat Skirt



Also Available:

### 7066-33 Sleep Sofa

87w 38d 37h  
 Note: For open sleeper dimensions, add approximately 55 inches from front of arm.



### 3077-3 Sofa

80w 36d 39h  
 Inside: 72w 22d 19h  
 Arm Height: 23 Seat Height: 20  
 Loose Pillow Back  
 Standard Throw Pillows: Two 21" x 21"  
 Standard Nail: #1-FN  
 Finish Shown: Carob Brown



3066-3 Sofa  
 DC5 Bench





**3078-2 Loveseat**

58w 38D 39H  
 Inside: 49w 22D 19H  
 Arm Height: 25 Seat Height: 20  
 Semi-Attached Backs  
 Standard Throw Pillows: Two 21" x 21"  
 Standard Nail: #1-FN  
 Finish Shown: Carob Brown

**3078-3 Sofa**

82w 38D 39H  
 Inside: 73w 22D 19H  
 Arm Height: 25 Seat Height: 20  
 Semi-Attached Backs  
 Standard Throw Pillows: Two 21" x 21"  
 Standard Nail: #1-FN  
 Finish Shown: Carob Brown



Also Available:

**7078-33 Sleep Sofa**

79w 38D 39H

Note: For open sleeper dimensions, add approximately 55 inches from front of arm.

**3097-2 Loveseat**

57w 38D 36H  
 Inside: 42w 21D 17H  
 Arm Height: 25 Seat Height: 19  
 Semi-Attached Back  
 Standard Throw Pillows: Two 21" x 21"  
 Standard With Kick Pleat Skirt

**3097-3 Sofa**

80w 38D 36H  
 Inside: 65w 21D 17H  
 Arm Height: 25 Seat Height: 19  
 Semi-Attached Backs  
 Standard Throw Pillows: Two 21" x 21"  
 Standard With Kick Pleat Skirt



Also Available:

**7097-33 Sleep Sofa**

81w 38D 36H

Note: For open sleeper dimensions, add approximately 55 inches from front of arm.

**3100-2 Loveseat**

58w 38D 37H  
 Inside: 48w 21D 19H  
 Arm Height: 25 Seat Height: 18  
 Loose Pillow Back  
 Standard Throw Pillows: Two 21" x 21"  
 Finish Shown: Carob Brown



Also Available:

**7100-22 Sleep Loveseat**

58w 38D 37H

Note: For open sleeper dimensions, add approximately 55 inches from front of arm.

**3100-3 Sofa**

80w 38D 37H  
 Inside: 70w 21D 19H  
 Arm Height: 25 Seat Height: 18  
 Loose Pillow Back  
 Standard Throw Pillows: Two 21" x 21"  
 Finish Shown: Carob Brown



Also Available:

**7100-33 Sleep Sofa**

80w 38D 37H

Note: For open sleeper dimensions, add approximately 55 inches from front of arm.





**3100-4 Sofa**

87w 38d 37h  
 Inside: 77w 21d 19h  
 Arm Height: 25 Seat Height: 18  
 Loose Pillow Back  
 Standard Throw Pillows: Two 21" x 21"  
 Finish Shown: Carob Brown

**3113-4 Sofa**

86w 34d 34h  
 Inside: 74w 22d 15h  
 Arm Height: 30 Seat Height: 19  
 Tight Tufted Back  
 Standard Throw Pillows: Two 21" x 21"  
 Standard With Recessed Wood Legs

**3113-2 Loveseat**

60w 34d 34h  
 Inside: 48w 22d 15h  
 Arm Height: 30 Seat Height: 19  
 Tight Tufted Back  
 Standard Throw Pillows: Two 21" x 21"  
 Standard With Recessed Wood Legs

**3131-2 Loveseat**

62w 38d 37h  
 Inside: 44w 22d 18h  
 Arm Height: 26 Seat Height: 19  
 Semi-Attached Backs  
 Standard Throw Pillows: Two 21" x 21"  
 Standard Nail: #1-FN  
 Finish Shown: Carob Brown

**3113-3 Sofa**

71w 34d 34h  
 Inside: 59w 22d 15h  
 Arm Height: 30 Seat Height: 19  
 Tight Tufted Back  
 Standard Throw Pillows: Two 21" x 21"  
 Standard With Recessed Wood Legs

**3131-3 Sofa**

84w 38d 37h  
 Inside: 66w 22d 18h  
 Arm Height: 26 Seat Height: 19  
 Semi-Attached Backs  
 Standard Throw Pillows: Two 21" x 21"  
 Standard Nail: #1-FN  
 Finish Shown: Carob Brown



Also Available:

**7131-33 Sleep Sofa**

87w 38d 37h

Note: For open sleeper dimensions, add approximately 55 inches from front of arm.





**3136-2 Loveseat**

66w 36D 35H  
 Inside: 46w 21D 16H  
 Arm Height: 30 Seat Height: 19  
 Tight Tufted Back  
 Tight Seat  
 Standard Throw Pillows: Two 21" x 21"  
 Finish Shown: Carob Brown

**3153-2 Loveseat**

60w 34D 34H  
 Inside: 47w 22D 15H  
 Arm Height: 30 Seat Height: 19  
 Tight Tufted Back  
 Standard Throw Pillows: Two 21" x 21"  
 Finish Shown: Carob Brown

**3153-3 Sofa**

71w 34D 34H  
 Inside: 59w 22D 15H  
 Arm Height: 30 Seat Height: 19  
 Tight Tufted Back  
 Standard Throw Pillows: Two 21" x 21"  
 Finish Shown: Carob Brown

**3153-4 Sofa**

88w 34D 34H  
 Inside: 74w 22D 15H  
 Arm Height: 30 Seat Height: 19  
 Tight Tufted Back  
 Standard Throw Pillows: Two 21" x 21"  
 Finish Shown: Carob Brown

**3157-2 Loveseat**

50w 36D 37H  
 Inside: 62w 21D 18H  
 Arm Height: 25 Seat Height: 19  
 Loose Pillow Back  
 Standard Throw Pillows: Two 21" x 21"  
 Finish Shown: Carob Brown

**3157-3 Sofa**

72w 36D 37H  
 Inside: 64w 21D 18H  
 Arm Height: 25 Seat Height: 19  
 Loose Pillow Back  
 Standard Throw Pillows: Two 21" x 21"  
 Finish Shown: Carob Brown



Also Available:

**7157-33 Sleep Sofa**

77w 36D 37H

Note: For open sleeper dimensions, add approximately 55 inches from front of arm.





**3159-3 Sofa**

84w 40D 36H  
 Inside: 66w 22D 17H  
 Arm Height: 26 Seat Height: 19  
 Tight Back  
 Standard Throw Pillows: Two 21" x 21"  
 Standard With Kick Pleat Skirt



Also Available:

**7159-33 Sleep Sofa**

87w 40D 36H

**3159-2 2-Cushion Loveseat**

62w 40D 36H

**7159-22 Sleep 2-Cushion Loveseat**

62w 40D 36H

Note: For open sleeper dimensions, add approximately 55 inches from front of arm.

**3164-2 Loveseat**

60w 36D 31H  
 Inside: 41w 23D 12H  
 Arm Height: 31 Seat Height: 19  
 Tight Tufted Back  
 Standard Throw Pillows: Two 21" x 21"  
 Standard Nail: #1-FN  
 Finish Shown: Carob Brown

**3164-3 Sofa**

83w 36D 31H  
 Inside: 64w 23D 12H  
 Arm Height: 31 Seat Height: 19  
 Tight Tufted Back  
 Standard Throw Pillows: Two 21" x 21"  
 Standard Nail: #1-FN  
 Finish Shown: Carob Brown



Also Available:

**7164-33 Sleep Sofa**

83w 36D 31H

Note: For open sleeper dimensions, add approximately 55 inches from front of arm.

**3164-4 Sofa**

91w 36D 31H  
 Inside: 72w 23D 12H  
 Arm Height: 31 Seat Height: 19  
 Tight Tufted Back  
 Standard Throw Pillows: Two 21" x 21"  
 Standard Nail: #1-FN  
 Finish Shown: Carob Brown

**F322-03 Sofa**

100w 41D 32H  
 Inside: 75w 22D 13H  
 Arm Height: 32 Seat Height: 19  
 Tight Tufted Back  
 Standard Throw Pillows:  
 Two 21" x 21"  
 Standard Nail: #2-FN  
 Finish Shown: Carob Brown

**3255 Sofa**

76w 39D 35H  
 Inside: 64w 23D 15H  
 Arm Height: 26 Seat Height: 20  
 Crescent Front  
 Tight Tufted Back  
 Standard Throw Pillows: Two 21" x 21"  
 Standard with Recessed Wood Legs





3344 Sofa  
1146 Chairs  
965-883 Accent Table  
MH26321 Roundel Table  
MH23361-90  
Guimard Commode  
224-850 North Shore  
Cocktail Table



Chairs Shown In Silver Fox Finish



**3344 Sofa**

100w 40D 40H  
 Inside: 88w 22D 21H  
 Arm Height: 26 Seat Height: 19  
 Loose Pillow Back  
 Standard Throw Pillows:  
 Two Large 23" x 24"  
 One Medium 21" x 21"  
 Standard Nail: #1-FN  
 Standard With Dressmaker Skirt

**3419 Sofa**

85w 40D 36H  
 Inside: 72w 20D 17H  
 Arm Height: 27 Seat Height: 19  
 Serpentine Front  
 Loose Pillow Back  
 Standard Throw Pillows: Two 21" x 21"  
 Standard Nail: #1-FN  
 Standard With Dressmaker Skirt

**3421 Sofa**

85w 40D 36H  
 Inside: 73w 20D 17H  
 Arm Height: 27 Seat Height: 19  
 Loose Pillow Back  
 Standard Throw Pillows: Two 21" x 21"  
 Standard Nail: #1-FN  
 Standard With Dressmaker Skirt

**4021 Settee**

52w 37D 42H  
 Inside: 46w 21D 22H  
 Arm Height: 26 Seat Height: 20  
 Crescent Front  
 Tight Back  
 Standard Throw Pillows: Two 18" x 21"  
 Standard Nail: #1-FN  
 Finish Shown: Carob Brown

**F460-03 Sofa**

110w 43D 36H  
 Inside: 88w 23D 18D 19H  
 Arm Height: 23 Seat Height: 17  
 Loose Pillow Back  
 Standard Throw Pillows:  
 Two Kidney 15" x 32"  
 Only Available In Weathered Ash

**5245 Sofa**

96w 43D 33H  
 Inside: 84w 25D 15H  
 Arm Height: 25 Seat Height: 19  
 Crescent Front  
 Tight Back  
 Standard Throw Pillows:  
 Two 21" x 21"  
 Finish Shown: Carob Brown





1551-1 Chair  
4201-1U Chair  
F1558-03 Sofa  
VMA-320 Console  
965-883 Accent Table  
967-157 Calvert Lamp Table  
967-156 Calvert Oval Cocktail Table





### 5259 Sofa

95w 39d 37h  
 Inside: 21d 19h  
 Arm Height: 30 Seat Height: 18  
 Seat Depth Without Throw Pillows: 24  
 Tight Tufted Back & Seat  
 Standard Throw Pillows:  
 Two Large 22" x 22"  
 Two Medium 21" x 21"  
 One Kidney 17" x 22"  
 Standard Nail: #1-FN  
 Finish Shown: Carob Brown



### 5287 Sofa

100w 38d 36h  
 Inside: 87w 22d 17h  
 Arm Height: 31 Seat Height: 19  
 Loose Pillow Back  
 Standard Throw Pillows:  
 Two Medium 16" x 18"  
 Two Arm Bolsters 12" x 22"  
 Finish Shown: Carob Brown



F1660 Sofa





# the TRUMAN COLLECTION

8-Way Hand Tied Construction | Super UD Cushions | Fiber Down Throw Pillows



## 5598-T Sofa

96w 40d 35h  
Inside: 84w 24d 21h  
Arm Height: 22 Seat Height: 19  
Loose Pillow Back  
Standard Throw Pillows: Two 21" x 21"  
Standard With Recessed Wood Legs



## 5597-T Mid-Sofa

84w 40d 35h  
Inside: 72w 24d 21h  
Arm Height: 22 Seat Height: 19  
Loose Pillow Back  
Standard Throw Pillows: Two 21" x 21"  
Standard With Recessed Wood Legs



## 5500 Ottoman

21w 21d 18h  
Standard With Rollers



## 5501-T Chair

32w 33d 36h  
Inside: 22w 22d 21h  
Arm Height: 28 Seat Height: 19  
Loose Pillow Back  
Standard With Recessed Wood Legs



## SW5501-T Swivel Chair

32w 33d 36h  
Inside: 22w 22d 21h  
Arm Height: 28 Seat Height: 19  
Loose Pillow Back  
Standard With Swivel Base





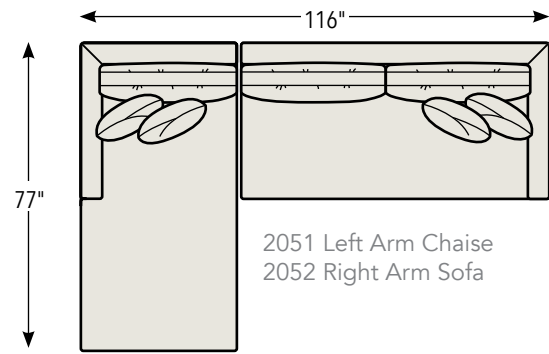

2051 Left Arm Chaise  
2052 Right Arm Sofa

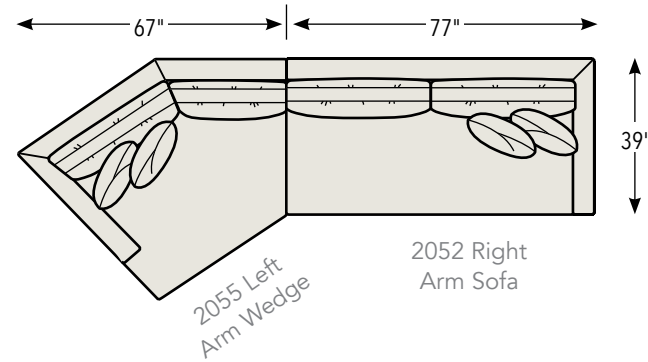

2055 Left Arm Wedge  
2052 Right Arm Sofa



2055 Left Arm Wedge  
2056 Armless Sofa  
2050 Right Arm Chaise

Standards:  
Loose Pillow Back  
Arm Height: 29"  
Seat Height: 19"  
Seat Depth: 21"  
Throw Pillow Size: 22" x 22"



2055 Left Arm Wedge  
2056 Armless Sofa  
2054 Right Arm Wedge  
230-930 Flint Round Lamp Table

Casegoods in photo are discontinued.

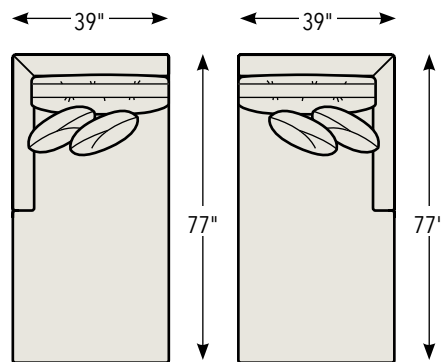

2051 Left Arm Chaise

2050 Right Arm Chaise

**2050 Right Arm Chaise**  
**2051 Left Arm Chaise**  
39w 54d 39h  
Overall Depth: 77  
Standard Throw Pillows: 2

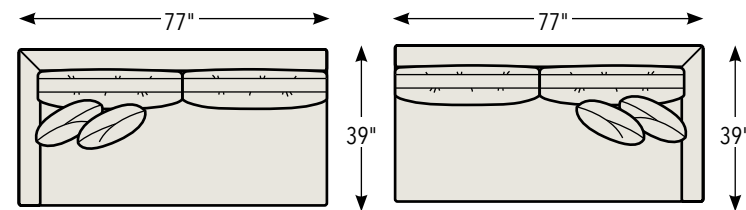

2053 Left Arm Sofa

2052 Right Arm Sofa

**2052 Right Arm Sofa**  
**2053 Left Arm Sofa**  
77w 24d 39h  
Overall Depth: 39  
Standard Throw Pillows: 2

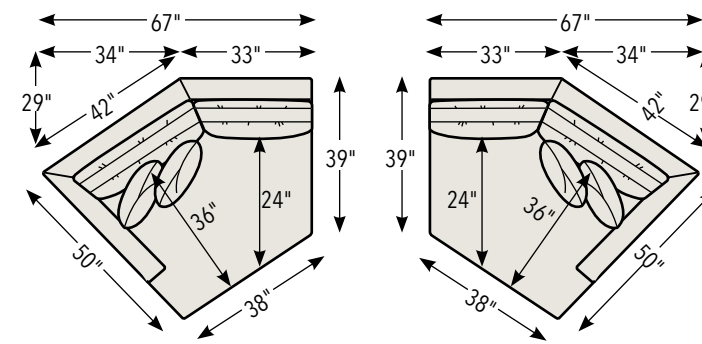

2055 Left Arm Wedge

2054 Right Arm Wedge

**2054 Right Arm Wedge**  
**2055 Left Arm Wedge**  
67w 36d 39h  
Overall Depth: 50  
Standard Throw Pillows: 2

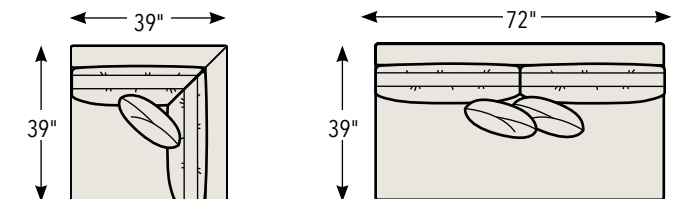

**2049 Corner Chair**  
39w 39h 24d  
Overall Depth: 39  
Standard Throw Pillows: 1

**2056 Armless Sofa**  
72w 24d 39h  
Overall Depth: 39  
Standard Throw Pillows: 2



**Standards:**

- Loose Pillow Back
- Arm Height: 25"
- Overall Depth: 38"
- Seat Depth: 21"
- Seat Height: 18"
- Throw Pillow Size: 21" x 21"



3185-LAC3 Left Arm Corner Sofa  
 3185-RA3 Right Arm Sofa  
 LW10329 Riley Nested Side Table - Antique Eglomise

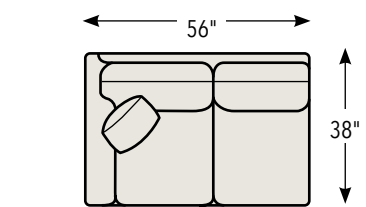

3185 LA2 Left Arm Loveseat  
 56w 21d 37h

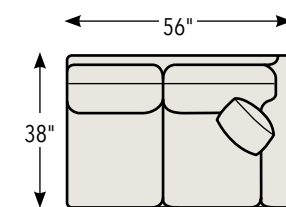

3184 RA2 Right Arm Loveseat  
 56w 21d 37h

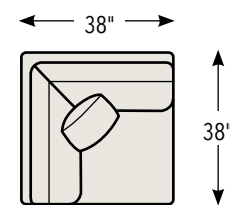

3183-C1 Corner Chair  
 38w 21d 37h

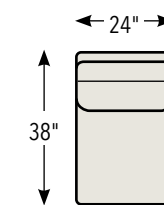

3181-AC1 Armless Chair  
 24w 21d 37h

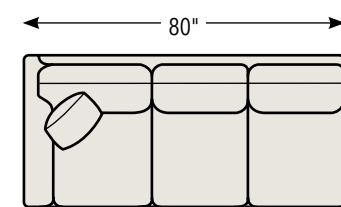

3187-LA3 Left Arm Sofa  
 80w 21d 37h

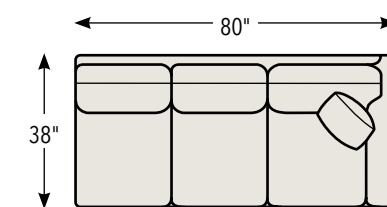

3186-RA3 Right Arm Sofa  
 80w 21d 37h

7187-LA33 Left Arm Sleep Sofa  
 76w 21d 37h

7186-RA33 Right Arm Sleep Sofa  
 76w 21d 37h

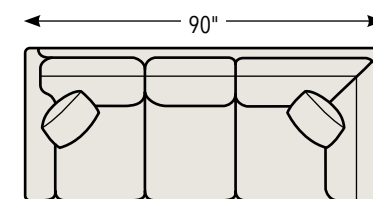

3189-LAC3 Left Arm Corner Sofa  
 90w 21d 37h

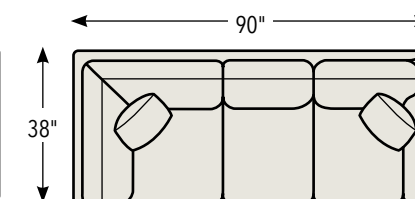

3188-RAC3 Right Arm Corner Sofa  
 90w 21d 37h

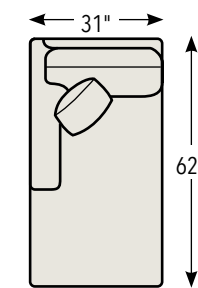

3199-LA1 Left Arm Chaise  
 31w 48d 37h  
 Overall Depth 62

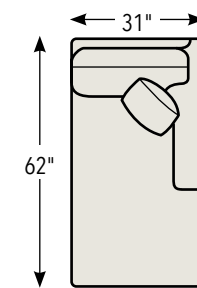

3198-RA1 Right Arm Chaise  
 31w 48d 37h  
 Overall Depth 62



3189-LAC3 Left Arm Corner Sofa  
 37h 90w 21d  
 Overall Depth: 38  
 Standard Throw Pillows: 2

3186-RA3 Right Arm Sofa  
 37h 80w 21d  
 Overall Depth: 38  
 Standard Throw Pillows: 1

Scale 1/4" = Approx. 1'



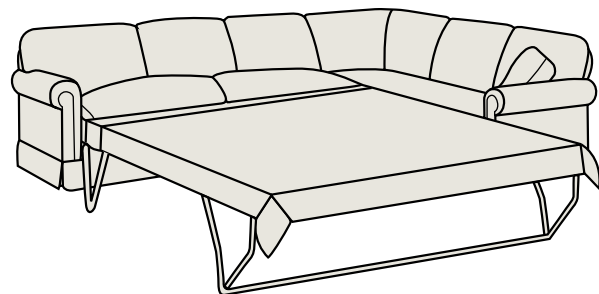

Sketched as: 7087-LA33 and 3088-RAC3

Note: For open sleeper dimensions, add approximately 55 inches from front of arm.

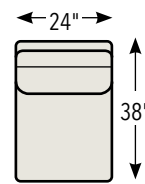

**3081 AC-1 Armless Chair**  
24w 38d 38h

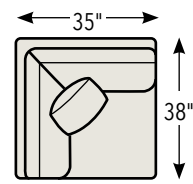

**3083-C1 Corner Chair**  
35w 38d 38h

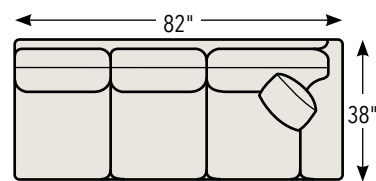

**3086 RA3 Right Arm Sofa**  
82w 38d 38h  
**7086 RA33 Right Arm Sleep Sofa**  
82w 38d 38h

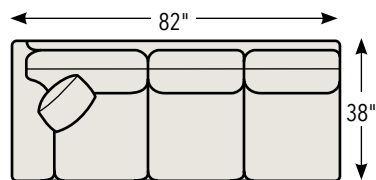

**3087 LA3 Left Arm Sofa**  
82w 38d 38h  
**7087 LA33 Left Arm Sleep Sofa**  
82w 38d 38h

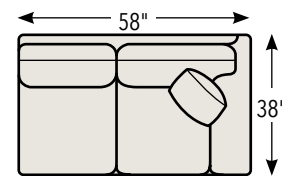

**3084 RA2 Right Arm Loveseat**  
58w 38d 38h

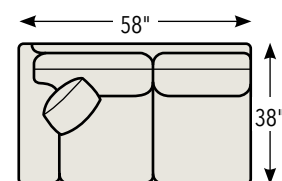

**3085 LA2 Left Arm Loveseat**  
58w 38d 38h

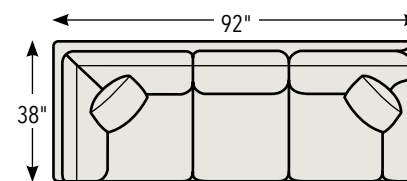

**3088 RAC3 Right Arm Corner Sofa**  
92w 38d 38h

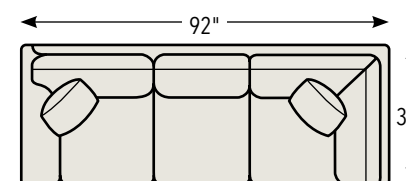

**3089 LAC3 Left Arm Corner Sofa**  
92w 38d 38h

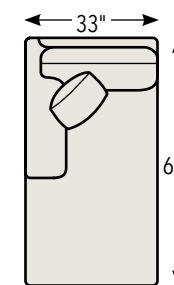

**3099 LA-1 Left Arm Chaise**  
33w 62d 38h  
Seat Depth: 48

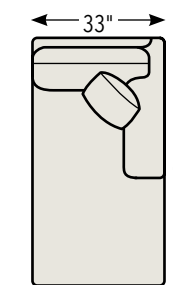

**3098 RA-1 Right Arm Chaise**  
33w 62d 38h  
Seat Depth: 48

Standards:  
Semi-Attached Back  
Arm Height: 25"  
Seat Depth: 21"  
Seat Height: 19"  
Throw Pillow Size: 21" x 21"

The 30 Series Sectional is available with standard "Scroll Panel Arm" or with optional "Pleated Arm." Please specify arm type when ordering.



Sketches Show Standard Throw Pillows.  
Scale 1/4" = Approx. 1'



SWL1450 Chair  
 CL-465 Dresser  
 L6060 Ottoman  
 964-108 Accent Table  
 F438-46 Right Arm Sofa  
 F438-33 Left Arm Corner Sofa



**Standards:**  
 Loose Pillow Back  
 Arm Height: 24"  
 Seat Height: 19"  
 Seat Depth: 24"  
 Standard Nail: #2-N  
 Standard With Brass Ferrules On Front Legs

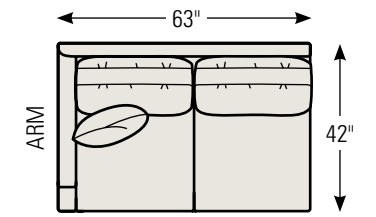

F438-32 Left Arm Loveseat

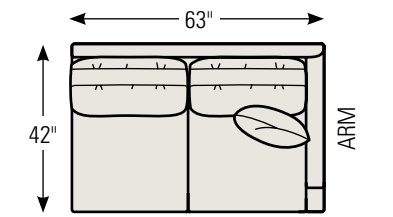

F438-42 Right Arm Loveseat

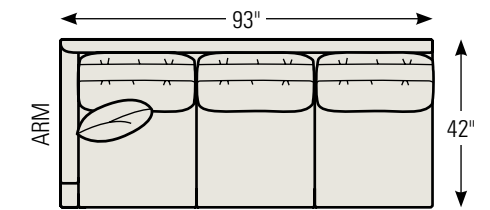

F438-36 Left Arm Sofa



**F438-33 Left Arm Corner Sofa**

103w 24d 38h  
 Overall Depth: 42  
 Loose Pillow Back  
 Standard Throw Pillows: Two 21" x 21"  
 Standard Nail #2-N  
 Standard With Brass Ferrules On Front Legs  
 Finish Shown: Brown Mahogany

**F438-46 Right Arm Sofa**

93w 24d 38h  
 Overall Depth: 42  
 Loose Pillow Back  
 Standard Throw Pillows: One 21" x 21"  
 Standard Nail #2-N  
 Standard With Brass Ferrules On Front Legs  
 Finish Shown: Brown Mahogany

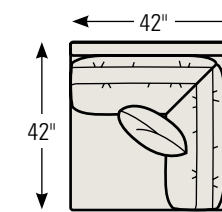

F438-44 Corner Chair

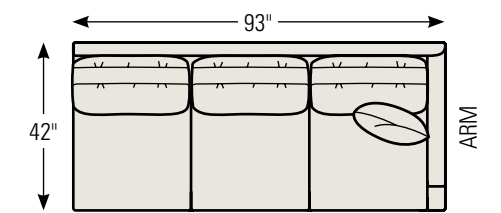

F438-46 Right Arm Sofa

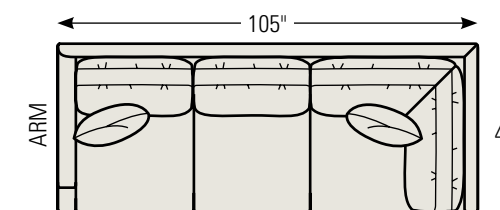

F438-33 Left Arm Corner Sofa

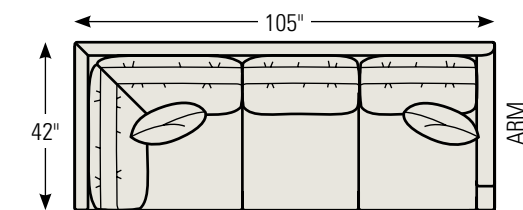

F438-43 Right Arm Corner Sofa





# 41 Series

The 41 Series featuring a “bump-out” front rail and upholstered base is available as a two or three cushion sofa/sleep sofa, matching chair/ottoman and a multi-piece sectional.



## 4133-3U Three Cushion Sofa

81w 21d 37h  
Standard with Two 21" Throw Pillows

- 4401-1U Chair
- 41-RA3U Right Arm Sofa
- 41-LAC3U Left Arm Corner Sofa
- VMA-034 Stirling Cabinet
- 215-940 Sonoma Square End Table
- 965-126N Trifecta Round Cocktail Table







# 41 Series



## 4122-4U Sofa

90w 38D 37H  
 Arm Height: 25 Seat Height: 19  
 Seat Depth: 21  
 Loose Pillow Back  
 Standard Throw Pillows: Two 21" x 21"  
 Available With U-Upholstered Base Only  
 All Sizes Approximate



## 41-LA3U Left Arm Sofa

78w 38D 37H  
 Standard Throw Pillows: One 21" x 21"  
 Shown With One Additional Throw Pillow

## 41-RA1U Right Arm Chaise

26w 48D 37H  
 Overall Depth: 64  
 Standard Throw Pillows: One 21" x 21"  
 Shown With One Additional Throw Pillow

## 4101-1U Chair

33w 38D 37H  
 Inside: 24w 21D 18H  
 Arm Height: 25 Seat Height: 19  
 Loose Pillow Back  
 Standard With Recessed Wood Legs



## 41 Series Available Styles

Shown in 1/4" scale

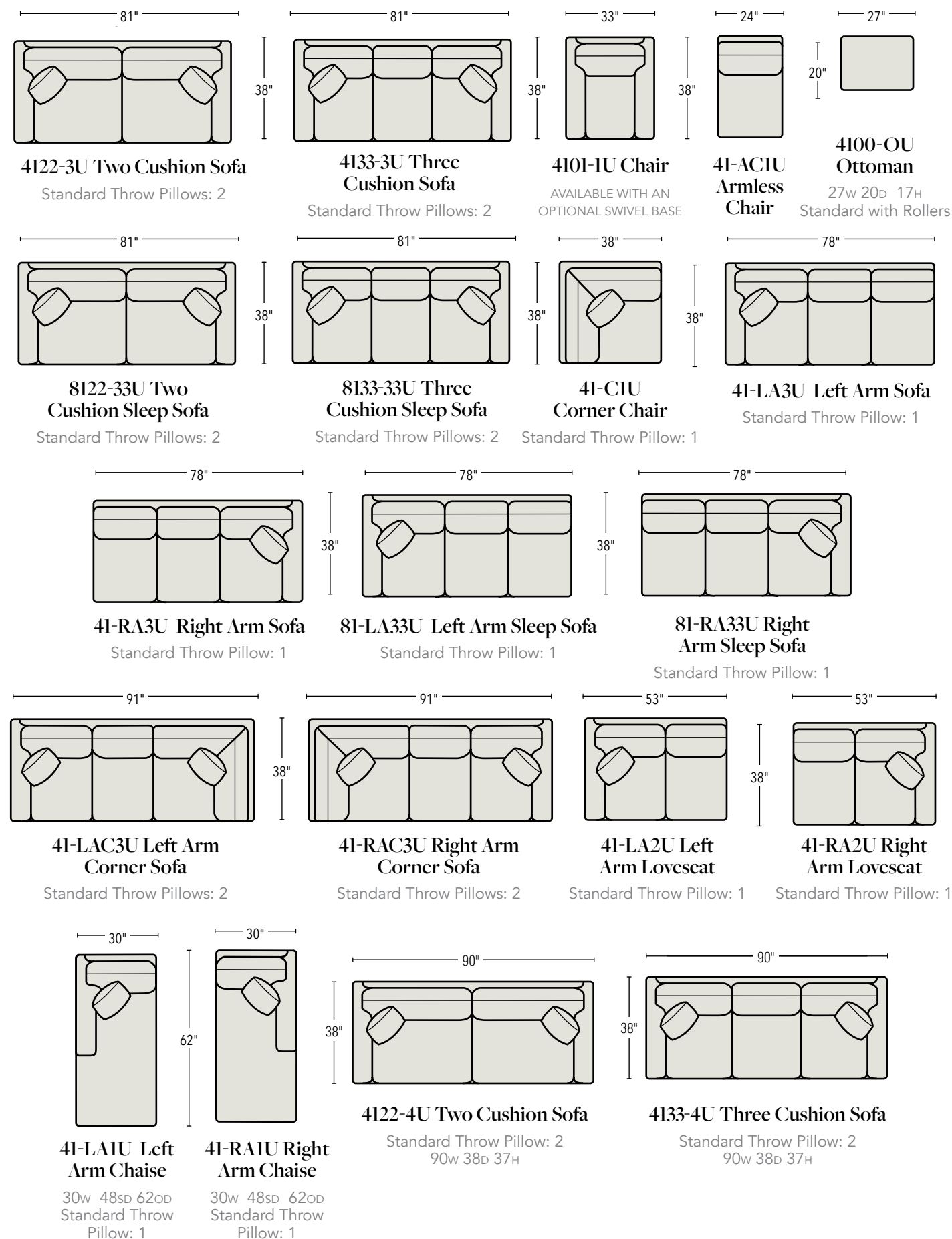



### 4122-4U Sofa

90w 38D 37H  
 Inside: 80w 21D 18H  
 Arm Height: 25 Seat Height: 19  
 Loose Pillow Back  
 Standard Throw Pillows: Two 21" x 21"  
 Standard With Recessed Wood Legs



### 4133-3U Sofa

81w 38D 37H  
 Inside: 71w 21D 18H  
 Arm Height: 25 Seat Height: 19  
 Loose Pillow Back  
 Standard Throw Pillows: Two 21" x 21"  
 Standard With Recessed Wood Legs



### 4133-4U Sofa

90w 38D 37H  
 Inside: 80w 21D 18H  
 Arm Height: 25 Seat Height: 19  
 Loose Pillow Back  
 Standard Throw Pillows: Two 21" x 21"



L4133-4U Sofa  
 966-059 Cork Drum End Table  
 966-058 Cork Drum Cocktail Table



Now Available in Leather, Whittemore Sherrill L41 Series





4222-4U Sofa  
W10 Lounge Chair  
971-110 Nash Cocktail Table

## 42 Series

The 42 Series features a moderately scaled rolled arm and casual bed-pillow back. This multi functional group is available with U-Upholstered Base or D-Dressmaker Skirt. The D or U suffix determines which base you have requested. See Page 81 for all the available styles and dimensions.



### 4201-U Chair

U = Upholstered Base  
35w 21D 37H  
Available With Optional Swivel Base

### 4200-OU Ottoman

U = Upholstered Base  
27w 20D 17H  
Standard With Rollers







# 42 Series



## 4222-4U Sofa

90w 36d 37h  
 Arm Height: 25 Seat Height: 19 Seat Depth: 21  
 Loose Pillow Back  
 Standard With Two 21" Throw Pillows  
 U=Upholstered Base



## 4222-3D Two Cushion Sofa

D = Dressmaker  
 82w 36d 37h  
 Inside: 70w 21d 18h  
 Standard Throw Pillows:  
 Two 21" x 21"

## 42-LA3U Left Arm Sofa

U = Upholstered Base  
 78w 36d 37h  
 Standard Throw Pillow: One 21" x 21"

## 42-RAC3U Right Arm Corner Sofa

U = Upholstered Base  
 88w 36d 37h  
 Standard Throw Pillows: Two 21 x 21"



## 42 Series Available Styles

Shown in 1/4" scale

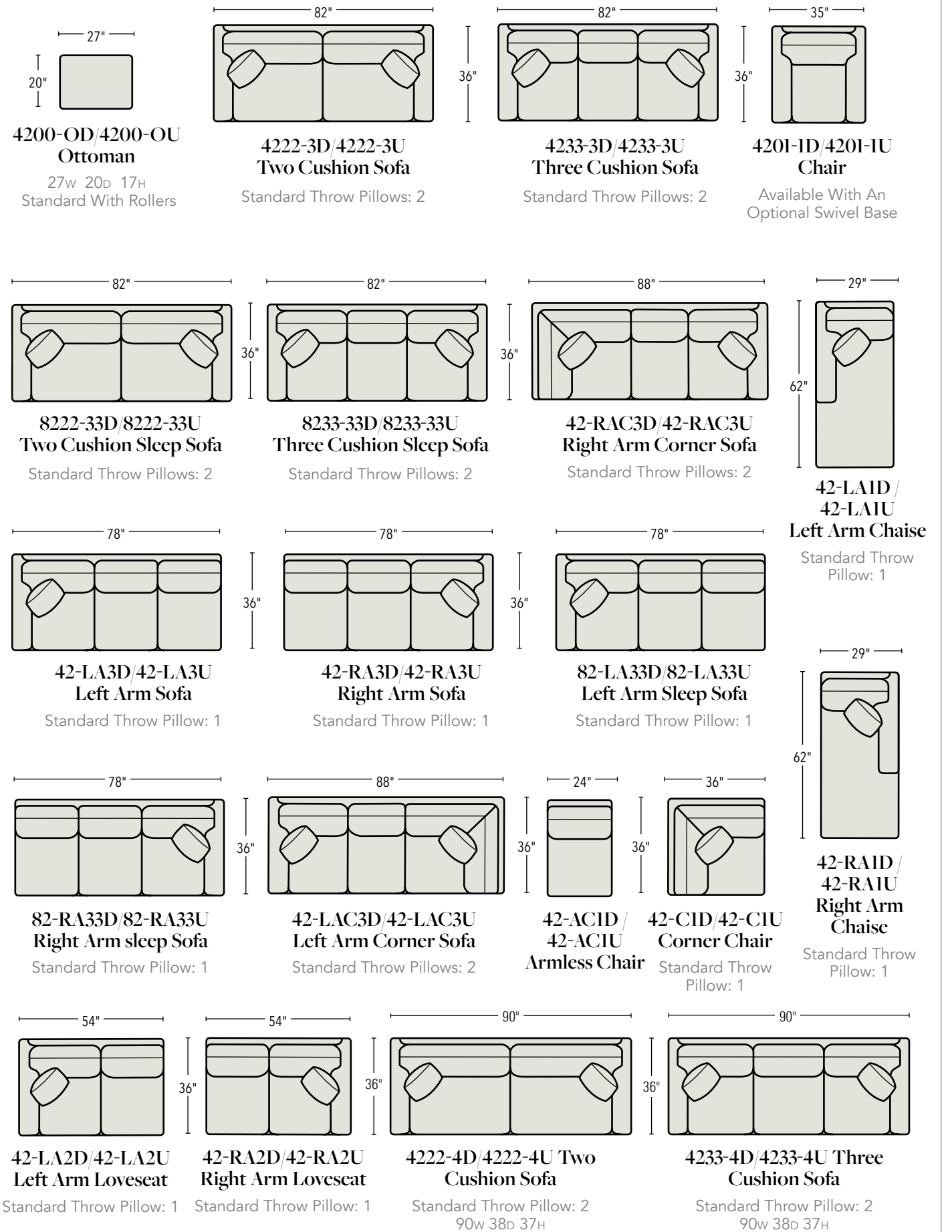





# 43 Series

The 43 Series featuring a thin crisp track arm and boxed loose pillow back is the perfect choice for an environment requiring moderately scaled furniture. This group is available with U-Upholstered Base or D-Dressmaker Skirt. The D or U suffix determines which base you have requested.



## 43-LA3D Left Arm Sofa

**D = Dressmaker Skirt**  
76w 36D 37H  
Standard With One 21" Throw Pillow

## 43-RAID Right Arm Chaise

**D = Dressmaker Skirt**  
27w 62D 37H  
Standard With One 21" Throw Pillow

4333-4U Sofa  
1578-1 Lounge Chair  
F420-01 Lounge Chair  
239-835 Manhattan Round Cocktail Table







# 43 Series



## 43 Series Available Styles

Shown in 1/4" scale

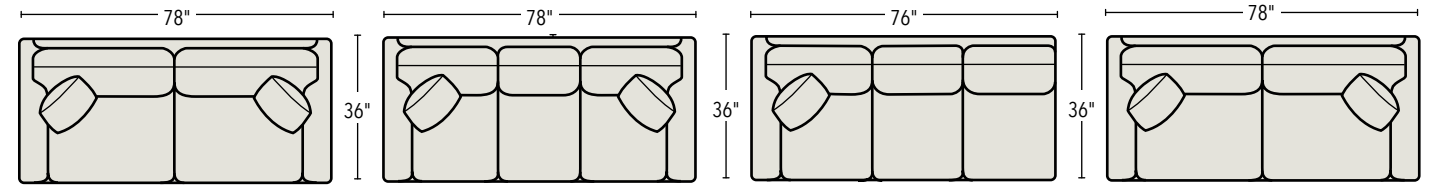

**4322-3D/4322-3U**  
Two Cushion Sofa

Standard Throw Pillows: 2

**4333-3D/4333-3U**  
Three Cushion Sofa

Standard Throw Pillows: 2

**43-LA3D/43-LA3U**  
Left Arm Sofa

Standard Throw Pillow: 1

**8322-33D/8322-33U**  
Two Cushion Sleep Sofa

Standard Throw Pillows: 2

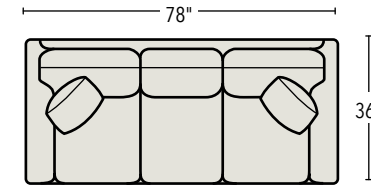

**8333-33D/8333-33U**  
Three Cushion Sleep Sofa

Standard Throw Pillows: 2

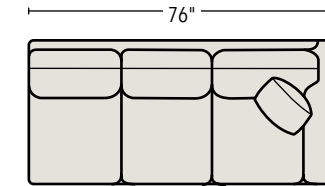

**43-RA3D/43-RA3U**  
Right Arm Sofa

Standard Throw Pillow: 1

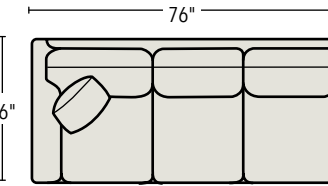

**83-LA33D/83-LA33U**  
Left Arm Sleep Sofa

Standard Throw Pillow: 1

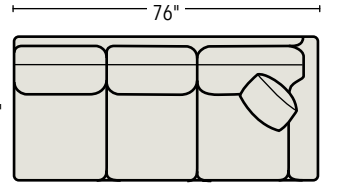

**83-RA33D/83-RA33U**  
Right Arm Sleep Sofa

Standard Throw Pillow: 1

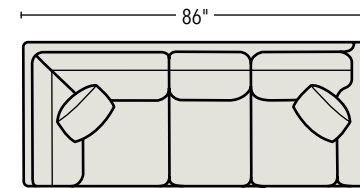

**43-RAC3D/43-RAC3U**  
Right Arm Corner Sofa

Standard Throw Pillows: 2

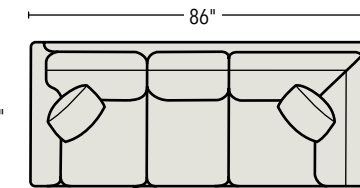

**43-LAC3D/43-LAC3U**  
Left Arm Corner Sofa

Standard Throw Pillows: 2

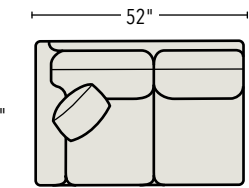

**43-LA2D/43-LA2U**  
Left Arm Loveseat

Standard Throw Pillow: 1

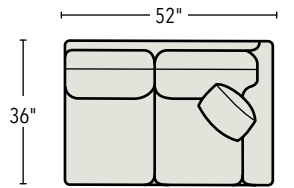

**43-RA2D/43-RA2U**  
Right Arm Loveseat

Standard Throw Pillow: 1

### 4322-4U Sofa

86w 36d 37h  
Arm Height: 24 Seat Height: 19 Seat Depth: 21  
Loose Pillow Back  
Standard With Two 21" Throw Pillows  
All Styles Available With D-Dressmaker Skirt Or  
U-Upholstered Base  
All Sizes Approximate



### 4322-3U Two Cushion Sofa With Upholstered Base

U = Upholstered Base  
78w 36d 37h  
Standard Throw Pillows: Two 21 x 21"

### 4301-1D Chair With Dressmaker Skirt

D = Dressmaker Skirt  
31w 36d 37h  
Available With Optional Swivel Base

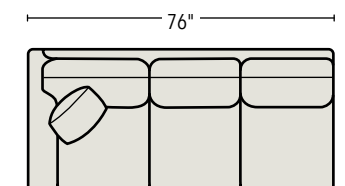

**43-LA3D/43-LA3U**  
Left Arm Sofa

Standard Throw Pillow: 1

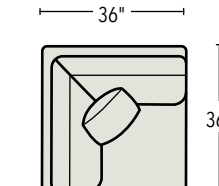

**43-CID/43-CIU**  
Corner Chair

Standard Throw Pillow: 1

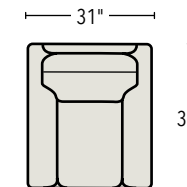

**4301-1D/4301-1U Chair**  
Available with an optional Swivel Base.

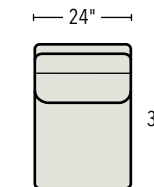

**43-ACID/43-ACIU**  
Armless Chair

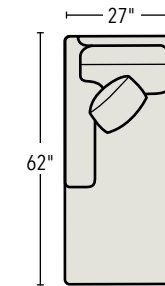

**43-LAID/43-LAIU**  
Left Arm Chaise  
27w 48sd 62od  
Standard Throw Pillow: 1

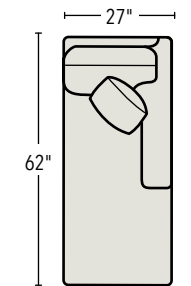

**43-RAID/43-RAIU**  
Right Arm Chaise  
27w 48sd 62od  
Standard Throw Pillow: 1

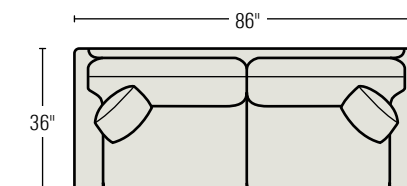

**4322-4D/4322-4U** Two Cushion Sofa

Standard Throw Pillow: 2  
86w 38d 37h

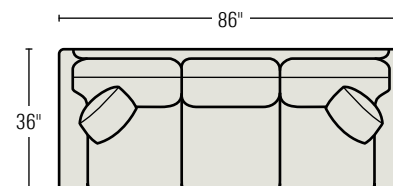

**4333-4D/4333-4U** Three Cushion Sofa

Standard Throw Pillow: 2  
86w 38d 37h

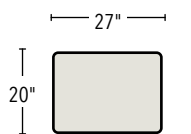

**4300-OD/4300-OU**  
Ottoman

27w 20d 17h  
Standard with Rollers





## 44 Series

The 44 Series features a bump-out front rail, modern flare arm style, and a boxed loose pillow back, perfect for today's relaxed look. This group is available in 18 styles with U-Upholstered base only.



4401-1U Chair  
44-LA1U Left Arm Chaise  
44-RA3U Right Arm Sofa  
970-650 Cullet Rectangle Cocktail Table





# 44 Series



## 44 Series Available Styles

Shown in 1/4" scale

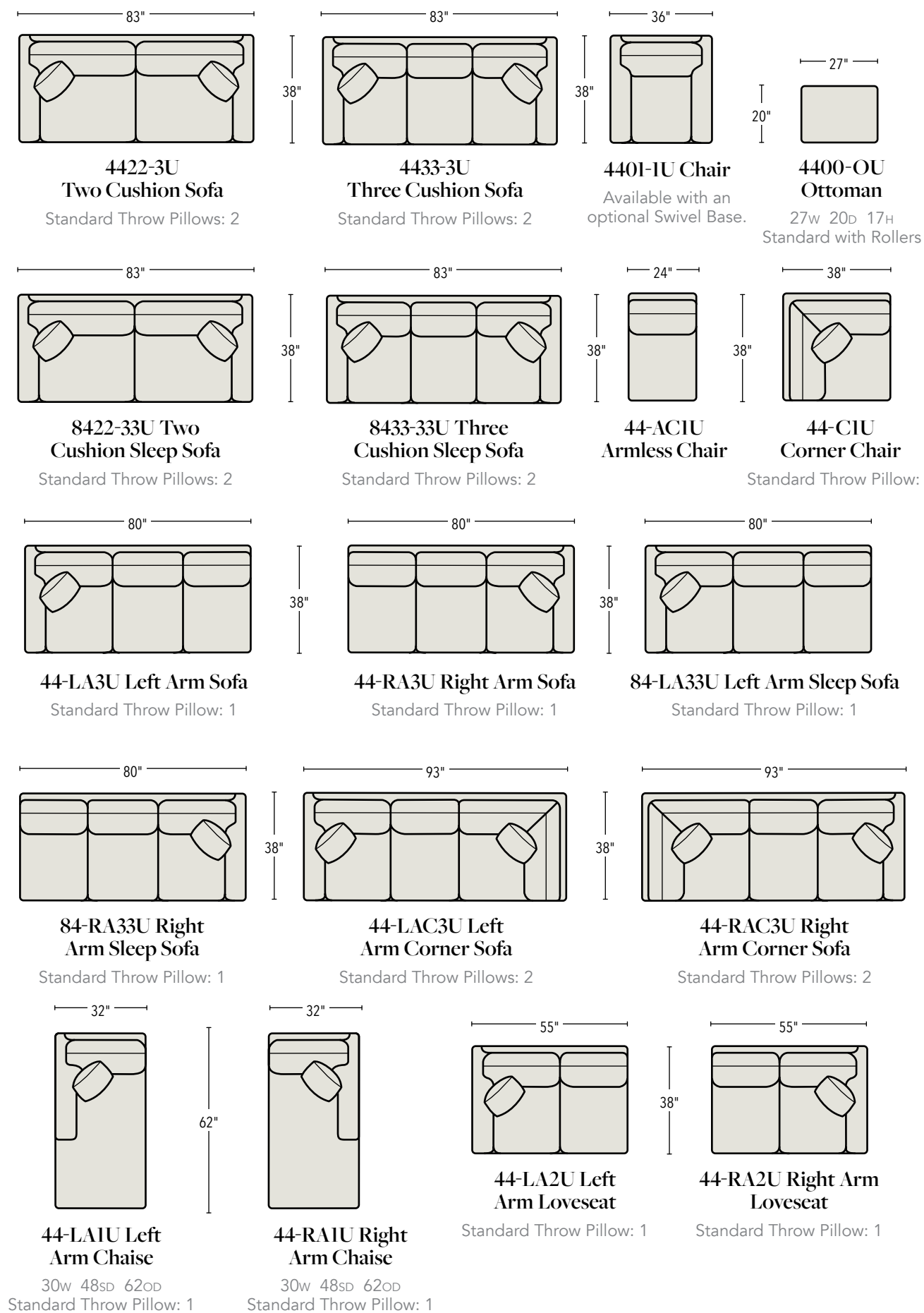

### 4401-U Chair

36w 38D 36H  
 Arm Height: 25 Seat Height: 19 Seat Depth: 21  
 Loose Pillow Back  
 Available With U-Upholstered Base Only  
 Standard With Recessed Wood Legs  
 All Sizes Approximate



### 4422-3U Two Cushion Sofa

83w 38D 36H  
 Loose Pillow Back  
 Arm Height: 25  
 Overall Depth: 38  
 Approx. Seat Height: 19  
 Standard Throw Pillows: 21" x 21"

### 4401-IU Chair

36w 38D 36H  
 INSIDE: 24w 21D 17H  
 Loose Pillow Back  
 Arm Height: 25  
 Seat Height: 19  
 Available with Optional Swivel Base.





5598T Sofa  
5501-T Chair  
965-887 End Table  
965-885 Cocktail Table



## 45 Series

The 45 Series features a sloped crescent arm style, tapered legs, and a loose pillow back, ideal for a casual look. This group is available in 18 different styles.





# 45 Series



## 45LA3U Left Arm Sofa

80w 38d 37h  
 Arm Height: 29 Seat Height: 20 Seat Depth: 21  
 Loose Pillow Back  
 Standard With Two 21" Throw Pillows  
 Available With U-Upholstered Base Only  
 All Sizes Approximate



## 45RA1U Right Arm Chaise

32w 38d 37h  
 Arm Height: 29 Seat Height: 20 Seat Depth: 21  
 Loose Pillow Back  
 Standard With Two 21" Throw Pillows  
 Available With U-Upholstered Base Only  
 All Sizes Approximate



## 4533-3U Sofa

80w 38d 37h  
 Inside: 72w 21d 17h  
 Arm Height: 29 Seat Height: 20  
 Loose Pillow Back  
 Standard Throw Pillows: Two 21" x 21"  
 Finish Shown: Carob Brown



## 4501-1U Chair

36w 38d 37h  
 Inside: 24w 21d 17h  
 Arm Height: 29 Seat Height: 20  
 Loose Pillow Back  
 Finish Shown: Carob Brown



### 45 Series Available Styles Shown in 1/4" scale

 <b>4522-3U Two Cushion Sofa</b> Standard Throw Pillows: 2	 <b>4533-3U Three Cushion Sofa</b> Standard Throw Pillows: 2	 <b>4501-1U Chair</b> Available with an optional Swivel Base.	 <b>4500-OU Ottoman</b> H17 W27 D20 Standard with Swivel Base
 <b>8522-33U Two Cushion Sleep Sofa</b> Standard Throw Pillows: 2	 <b>8533-33U Three Cushion Sleep Sofa</b> Standard Throw Pillows: 2	 <b>45-ACIU Armless Chair</b>	 <b>45-CIU Corner Chair</b> Standard Throw Pillow: 1
 <b>45-LA3U Left Arm Sofa</b> Standard Throw Pillow: 1	 <b>45-RA3U Right Arm Sofa</b> Standard Throw Pillow: 1	 <b>85-LA33U Left Arm Sleep Sofa</b> Standard Throw Pillow: 1	
 <b>85-RA33U Right Arm Sleep Sofa</b> Standard Throw Pillow: 1	 <b>45-LAC3U Left Arm Corner Sofa</b> Standard Throw Pillows: 2	 <b>45-RAC3U Right Arm Corner Sofa</b> Standard Throw Pillows: 2	
 <b>45-LA1U Left Arm Chaise</b> 30w 48sd 62od Standard Throw Pillow: 1	 <b>45-RA1U Right Arm Chaise</b> 30w 48sd 62od Standard Throw Pillow: 1	 <b>45-LA2U Left Arm Loveseat</b> Standard Throw Pillow: 1	 <b>45-RA2U Right Arm Loveseat</b> Standard Throw Pillow: 1





## 46 Series

The 46 Series features a narrow track arm with a cross-over seam and loose pillow back construction for a casual relaxed take on a modern sofa style. This group is available in 20 styles with U-Upholstered Base only.

967-142 Etagere  
1635-P Lounge Chair  
971-111 Nash End Table  
971-110 Nash Cocktail Table  
46-LA3U Left Arm Sofa  
46-RAC3U Right Arm Corner Sofa







# 46 Series



## 46 Series Available Styles

Shown in 1/4" scale

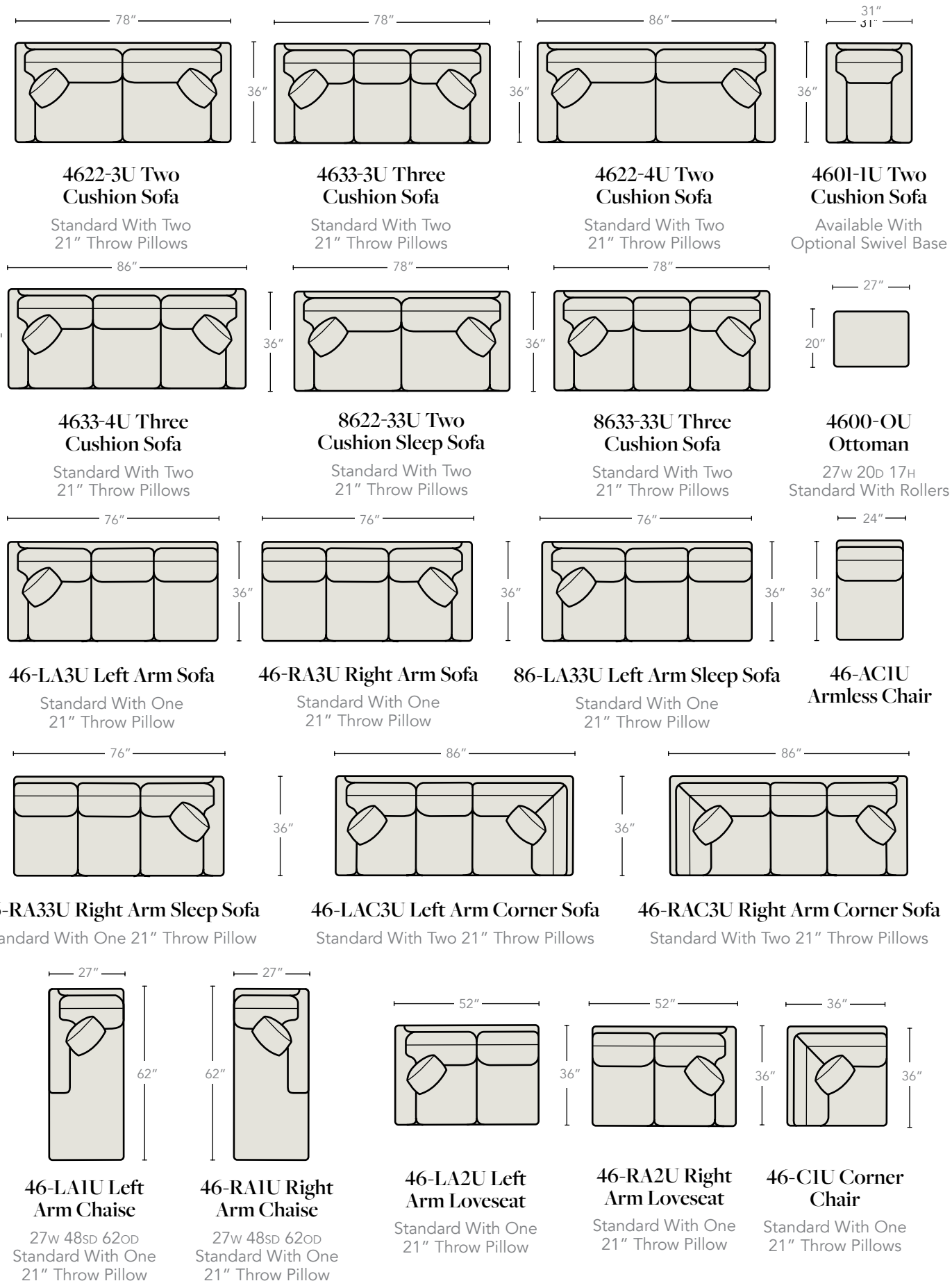

\*Available With U-Upholstered Base Only.

### 4633-4U Sofa

86w 36d 40h  
 Arm Height: 23 Seat Height: 19 Seat Depth: 21  
 Loose Pillow Back  
 Standard With Two 21" Throw Pillows



### 4633-4U Sofa

86w 36d 40h  
 Inside: 78w 21d 21h  
 Arm Height: 23 Seat Height: 19  
 Loose Pillow Back  
 Standard With Two 21" Throw Pillows  
 Standard With Recessed Legs



### 4601-1U Chair

31w 36d 40h  
 Inside: 20w 21d 18h  
 Arm Height: 23 Seat Height: 19  
 Loose Pillow Back  
 Shown With Optional #1-FN Nails  
 Standard With No Nail Trim  
 Standard With Recessed Wood Legs







DC104 Bench  
M29-40 Cocktail Table  
DC5 Bench / Ottoman  
241-960 Palm Beach End Table  
96RSSFAH Right Arm Sofa  
96LNSFAH Left Arm Corner Sofa



# 96/9700 Series Design Your Own

All the Design Your Own Series frames are available in the traditional 96 series scale or the more generously scaled 97 series. The 96 or 97 prefix determines the scale of your sofa, chair or sectional. You can then personalize your frame choice by selecting arm, back and base options to suit your individual style.





# 9600/9700 Series Design Your Own

Design Your Own Series. Create your perfect chair, chair & half, sofa, loveseat and sectional by selecting the options below.

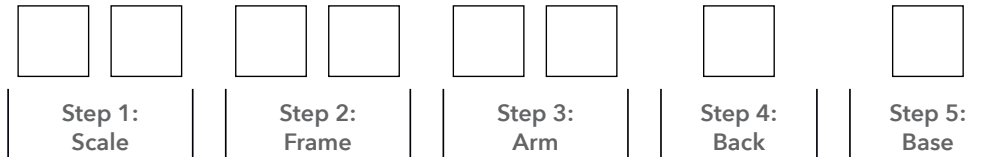

## 1 Select Your Scale

96 or 97 Series number indicates your depth and height.



## 2 Select Your Frame Style

\*Note: All frames are standard with welt. 2 weltless options are available for an up-charge. Specify (Weltless: French-Seam) or (Weltless: Double Needle)  
\*L-Lawson back heights are approximately 2" lower than standard.

### Chairs / Ottoman / Sofas:

- 01 - Chair
- 00 - Ottoman
- 11 - Chair & 1/2
- 10 - Large Ottoman
- 02 - Two Cushion 66" Loveseat
- 23 - Two Cushion 80" Sofa
- 33 - Three Cushion 80" Sofa
- 24 - Two Cushion 88" Sofa
- 34 - Three Cushion 88" Sofa
- 25 - Two Cushion 97" Sofa
- 35 - Three Cushion 97" Sofa

### Sectional Pieces:

- LC - Left Arm Chair
- RC - Right Arm Chair
- LL - Left Arm Loveseat
- RL - Right Arm Loveseat
- LS - Left Arm Sofa
- RS - Right Arm Sofa
- LN - Left Arm Corner Sofa
- RN - Right Arm Corner Sofa
- LZ - Left Arm Chaise
- RZ - Right Arm Chaise
- LA - Left Angle Loveseat
- RA - Right Angle Loveseat
- AL - Armless Loveseat
- AC - Armless Chair
- AS - Armless Sofa
- SO - Sectional Ottoman
- SC - Sectional Chair
- CC - Curved Corner

### 96 - Series Dimensions

Height: 37 in.  
Overall Depth: 38 in.  
Seat Depth: 22 in.

### 97 - Series Dimensions

Height: 39 in.  
Overall Depth: 41 in.  
Seat Depth: 24 in.

## Standard Construction

Arm Height: 25 in.  
Approximate Seat Height: 19 in.  
Standard Finish: Antique Walnut, Exposed Wood base  
Also available in any "Custom Line" Finish  
Skirted and Upholstered Bases are standard and only available in: Walnut  
\*L - Lawson Back Heights are approximately 2" lower than standard.  
\*Standard Throw Pillows are 21" x 21"

## 3 Select Your Arm Style

\*NOTE: All arms are standard with welt.



T-Cushion  
Curved Front Base/Leg

- A - Cap
- B - Bistro
- E - English
- F - Fan
- K - Key
- M - Modern
- N - Narrow Track
- P - Pleated
- R - Rolled
- S - Sock
- T - Track
- W - Wide Cap



T-Cushion  
Square Front Base/Leg

- AS - Cap Square
- BS - Bistro Square
- ES - English Square
- FS - Fan Square
- KS - Key Square
- MS - Modern Square
- NS - Narrow Track Square
- PS - Pleated Square
- RS - Rolled Square
- SS - Sock Square
- TS - Track Square
- WS - Wide Cap Square



Arm To The Front  
Square Front Base/Leg

- AF - Cap Front
- BF - Bistro Front
- CF - Crescent Front
- EF - English Front
- FF - Fan Front
- KF - Key Front
- LF - Large Crescent Front
- MF - Modern Front
- NF - Narrow Track Front
- PF - Pleated Front
- RF - Rolled Front
- SF - Sock Front
- TF - Track Front
- WF - Wide Cap Front

## 4 Select Your Back Style



B - Box (Loose)



K - Knife (Loose)



A - Attached Box



S - Semi-Attached Knife



L - Lawson\*



T - Tight



C - Casual Back (Loose)

## 5 Select Your Base Style



S - Skirt



D - Dressmaker



U - Upholstered

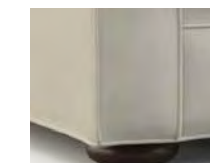

B - Bun  
Foot Height = 2"



W - Wood Foot  
Foot Height = 2"



L - Large Tapered Block  
Foot Height = 2"



T - Tapered  
Foot Height = 2"

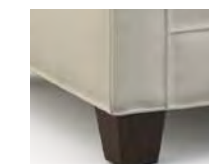

H - High Tapered  
Foot Height = 4"



G - Grand Turned  
Foot Height = 4"



T-Cushion Arm Options

- ☐■ - T Cushion With Curved Front Base/Leg
- ☐☐ - T Cushion With Square Front Base/Leg



**A -Cap Arm**  
AS-Cap/Square (Shown)  
Arm Width = 4"



**B-Bistro**  
BS-Bistro/Square (Shown)  
Arm Width = 4"



**E-English (Shown)**  
ES-English/Square  
Arm Width = 6"



**F-Fan**  
FS-Fan/Square (Shown)  
Arm Width = 4"



**K-Key**  
KS-Key/Square (Shown)  
Arm Width = 5½"



**M-Modern**  
\*MS-Modern/Square (Shown)  
Arm Width = 4"



**N-Narrow Track**  
NS-Narrow/Square (Shown)  
Arm Width = 4"



**P-Pleated (Shown)**  
PS-Pleated/Square  
Arm Width = 8"



**R-Rolled**  
RS-Rolled/Square (Shown)  
Arm Width = 8"



**S-Sock**  
SS-Sock/Square (Shown)  
Arm Width = 8"



**T-Track**  
TS-Track/Square (Shown)  
Arm Width = 6"



**W-Wide Cap**  
WS-Wide Cap Square (Shown)  
Arm Width = 6"

Arms to the Front Arm Options

- ☐☐ - Arms to the Front
- All Standard With Square Front Leg/Base



**AF-Cap Arm**  
Arm Width = 4"



**BF-Bistro Front**  
Arm Width = 4"



**CF-Crescent Front**  
(Only Available To The Front)  
Arm Width = 4"



**EF-English Front**  
Arm Width = 6"



**FF-Fan Front**  
Arm Width = 4"



**KF-Key Front**  
Arm Width = 5½"



**\* LF-Large Crescent Front**  
(Only Available To The Front)  
Arm Width = 6"



**MF-Modern Front**  
Arm Width = 4"



**NF-Narrow Track Front**  
Arm Width = 4"



**PF-Pleated Front**  
Arm Width = 8"



**RF-Rolled Front**  
Arm Width = 8"



**SF-Sock Front**  
Arm Width = 8"



**TF-Track Front**  
Arm Width = 6"



**WF-Wide Cap Front**  
Arm Width = 6"

\* NOTE Arm shown with Weltless French Seam option. All arms are standard with welt.



## Back Options



B-Box Loose



K-Knife Loose



A-Attached Box (Semi)



C-Casual  
(Only Available Loose)



S-Semi Attached  
Knife Edge



T-Tight



L-Lawson\*

\* L - Lawson Back option will lower back height approximately 2 inches.

## Base Options

T-TAPERED  
Foot Width = 4"  
Foot Height = 2"



L-LARGE  
TAPERED BLOCK  
Foot Width = 5"  
Foot Height = 2"



W-WOOD  
Foot Width = 7"  
Foot Height = 2"



H-HIGH  
TAPERED\*\*  
Foot Width = 4"  
Foot Height = 4"



G-GRAND  
TURNED\*\*  
Foot Width = 5"  
Foot Height = 4"

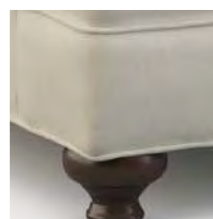

When Using  
"T" Cushion

When Using  
Arms To  
The Front

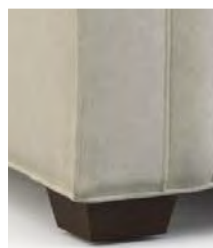

\*\*Base Options H and G will raise seat height approximately one inch.

## Two Weltless Options

Available for an upcharge. "Weltless: Double Needle" and "Weltless: French Seam".  
This option must be specified on your order as "Special Application"



Weltless: Double  
Needle



Weltless: French  
Seam

### 9701-MSBD CHAIR

OPTIONS SHOWN:

**97**: 41" Depth

**01**: Chair

**MS**: Modern/Square Arm

**B**: Box (Loose) Back

**D**: Dressmaker Skirt

Special Application:  
Shown with "Weltless French Seam"



Weltless French Seam

## Base Options

S-SKIRT



D-DRESSMAKER



U-UPHOLSTERED



B-BUN  
Foot Width = 6"  
Foot Height = 2"



When Using  
"T" Cushion

When Using  
Arms To  
The Front

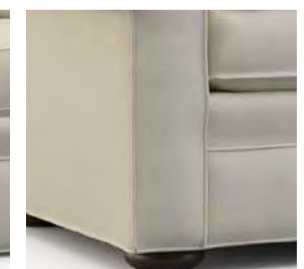

\*Note: Arms to the front will square the front corner/base (see examples)





**9623-FFCU Two Cushion 80" Sofa**

80w 22d 37h  
 25AH 38OD 19SH  
 Standard Throw Pillows: 2  
 Options Shown:  
 96: 38" Depth  
 23: 2-Cushion 80" Sofa  
 FF: Fan Front Arm  
 C: Casual (Loose) Back  
 U: Upholstered Base  
 Shown With Optional "Weltless French Seam" Application - Must Specify



**9623-MFCU Two Cushion 80" Sofa**

80w 22d 37h  
 25AH 38OD 19SH  
 Standard Throw Pillows: 2 (Not Shown)  
 Options Shown:  
 96: 38" Depth  
 23: 2-Cushion 80" Sofa  
 MF: Modern Front Arm  
 C: Casual (Loose) Back  
 U: Upholstered Base



**9624-KSLT Two Cushion 88" Sofa**

88w 22d 37h  
 25AH 38OD 19SH  
 Standard Throw Pillows: 2  
 Options Shown:  
 96: 38" Depth  
 24: 2-Cushion 88" Sofa  
 KS: Key/Square Arm  
 L: Lawson Back  
 T: Tapered Leg



**9624-NFSH Two Cushion 88" SOFA**

88w 22d 37h  
 25AH 38OD 20SH  
 Standard Throw Pillows: 2  
 Options Shown:  
 96: 38" Depth  
 24: 2-Cushion 88" Sofa  
 NF: Narrow Track Front Arm  
 S: Semi Attached Back  
 H: High Tapered Leg



**9623-NLT Two Cushion 80" Sofa**

80w 22d 35h  
 25AH 38OD 19SH  
 Standard Throw Pillows: 2  
 Finish Shown: Antique Walnut  
 Options Shown:  
 96: 38" Depth  
 23: 2-Cushion 80" Sofa  
 N: Narrow Track Arm  
 L: Lawson Back  
 T: Tapered Leg



**9623-PSD Two Cushion 80" Sofa**

80w 22d 37h  
 25AH 38OD 19SH  
 Options Shown:  
 96: 38" Depth  
 23: 2-Cushion 80" Sofa  
 P: Pleated Arm  
 S: Semi Attached Knife Edge Back  
 D: Dressmaker



**9634-RBS Three Cushion 88" Sofa**

88w 22d 37h  
 25AH 38OD 19SH  
 Standard Throw Pillows: 2  
 Options Shown:  
 96: 38" Depth  
 34: 3-Cushion 88" Sofa  
 R: Rolled Arm  
 B: Box (Loose) Back  
 S: Skirt



**9724-CFAU Two Cushion 88" Sofa**

88w 24d 39h  
 25AH 41OD 19SH  
 Standard Throw Pillows: 2 (Not Shown)  
 Options Shown:  
 97: 41" Depth  
 24: 2-Cushion 88" Sofa  
 CF: Crescent Front Arm  
 A: Attached Box (Semi) Back  
 U: Upholstered Base





### 9702-PFBS Loveseat

66w 24d 39h  
25AH 41OD 19SH  
Standard Throw Pillows: 2  
Options Shown:  
97: 41" Depth  
02: 2-Cushion 66" Loveseat  
PF: Pleated Front  
B: Box (Loose) Back  
S: Skirt



### 9723-NFLH Two Cushion 80" Sofa

37h 80w 24d  
25AH 41OD 20SH  
Shown with optional #1-FN Nails  
Standard Throw Pillows: 2  
Finish Shown: Antique Walnut  
Options Shown:  
97: 41" Depth  
23: 2-Cushion 80" Sofa  
NF: Narrow Track Front Arm  
L: Lawson Back  
H: High Tapered Leg



### 9734-EFKB Three Cushion 88" Sofa

39h 88w 24d  
25AH 41OD 19SH  
Standard Throw Pillows: 2  
Options Shown:  
97: 41" Depth  
34: 3-Cushion 88" Sofa  
EK: English Front Arm  
K: Knife (Loose) Back  
B: Bun Foot



### 9734-LFBH Three Cushion 88" Sofa

39h 88w 24d  
25AH 41OD 19SH  
Standard Throw Pillows: 2  
Options Shown:  
97: 41" Depth  
34: 3-Cushion 88" Sofa  
LF: Large Crescent Front Arm  
B: Box (Loose) Back  
H: High Tapered Leg



### 9733-SBT Three Cushion 80" Sofa

39h 80w 24d  
25AH 41OD 19SH  
Standard Throw Pillows: 2  
Options Shown:  
97: 41" Depth  
33: 3-Cushion 80" Sofa  
S: Sock  
B: Box (Loose) Back  
T: Tapered Leg



### 9734-BFCD Three Cushion 88" Sofa

39h 88w 24d  
25AH 41OD 20SH  
Standard Throw Pillows: 2 (Not Shown)  
Options Shown:  
97: 41" Depth  
34: 3-Cushion 88" Sofa  
BF: Bistro Front  
C: Casual (Loose) Back  
D: Dressmaker Skirt



### 9734-NFBH Three Cushion 88" Sofa

88w 24d 39h  
25AH 41OD 20SH  
Standard Throw Pillows: 2  
Options Shown:  
97: 41" Depth  
34: 3-Cushion 88" Sofa  
NF: Narrow Track Front Arm  
B: Box (Loose) Back  
H: High Tapered Leg  
"Weltless French Seam"  
Application - Must Specify



### 9725-WSBL Two Cushion 97" Sofa

39h 97w 24d  
25AH 41OD 20SH  
Standard Throw Pillows: 2  
Options Shown:  
97: 41" Depth  
25: 2-Cushion 97" Sofa  
WS: Wide Cap Square Arm  
B: Box (Loose) Back  
L: Large Tapered Block Base



9611-EFKG Chair & Half  
50W 38D 37H  
Standard Throw Pillows: 2 - 21"

9610-XXG Large Ottoman  
42W 28D 17H



### 9601-CFLT Chair

33W 22D 35H  
25AH 38OD 19SH  
Options Shown:  
96: 38" Depth  
01: Chair  
CF: Crescent Front Arm  
L: Lawson Back  
T: Tapered Leg  
Shown With Optional  
"Weltless French Seam"  
Application - Must Specify



### 9601-BSCD Chair

33W 22D 37H  
25AH 38OD 19SH  
Options Shown:  
96: 38" Depth  
01: Chair  
BS: Bistro Square Arm  
C: Casual (Loose) Back  
D: Dressmaker Skirt



### 9601-NFLH CHAIR

33W 22D 35H  
25AH 38OD 20SH  
Options Shown:  
96: 38" Depth  
01: Chair  
NF: Narrow Track Front Arm  
L: Lawson Back  
H: High Tapered Leg





**9601-EFKD CHAIR**

33w 22d 37h  
 25AH 38OD 19SH  
 Options Shown:  
 96: 38" Depth  
 01: Chair  
 EF: English Front Arm  
 K: Knife (Loose) Back  
 D: Dressmaker



**9701-FSCT CHAIR**

33w 24d 39h  
 25AH 41OD 19SH  
 Options Shown:  
 97: 41" Depth  
 01: Chair  
 FS: Fan Square Arm  
 C: Casual (Loose) Back  
 T: Tapered Leg



**9701-MSBD Chair**

33w 24d 39h  
 25AH 41OD 19SH  
 Options Shown:  
 97: 41" Depth  
 01: Chair  
 MS: Modern Square Arm  
 B: Box (Loose) Back  
 D: Dressmaker Skirt  
 Shown with Optional  
 "Weltless French Seam" Application - Must Specify



**9701-XXS OTTOMAN**

40w 24d 39h  
 25AH 41OD 24D  
 Options Shown:  
 97: 41" Depth  
 01: Chair  
 P: Pleated Arm  
 K: Knife (Loose) Back  
 S: Skirt

**9700-XXS OTTOMAN**

30w 19d 17h  
 Standard With Rollers



**9601-KFAL CHAIR**

33w 22d 37h  
 25AH 38OD 19SH  
 Options Shown:  
 96: 38" Depth  
 01: Chair  
 KF: Key Front Arm  
 A: Attached Box (Semi) Back  
 L: Large Tapered Block



**9701-LFAL CHAIR**

33w 24d 39h  
 25AH 41OD 19SH  
 Options Shown:  
 97: 41" Depth  
 01: Chair  
 LF: Large Crescent Front Arm  
 A: Attached Box (Semi) Back  
 L: Large Tapered Block



**9701-SFTU CHAIR**

40w 24d 39h  
 25AH 41OD 19SH  
 Options Shown:  
 97: 41" Depth  
 01: Chair  
 SF: Sock Front Arm  
 T: Tight Back  
 U: Upholstered Base



**9601-AFBD CHAIR**

40w 24d 39h  
 25AH 41OD 19SH  
 Options Shown:  
 96: 38" Depth  
 01: Chair  
 AF: Cap Front Arm  
 B: Box (Loose) Back  
 D: Dressmaker Skirt



# 96/97 Design Your Own Sectionals



## 97LS-TFBL Left Arm Sofa

79w 24d 39h  
25AH 41OD 19SH  
Standard Throw Pillows: One 21" x 21"  
Shown With Optional "Weltless Double Needle" Application - Must Specify

## 97RN-TFBL Right Arm Corner Sofa

98w 24d 39h  
25AH 41OD 19SH  
Standard Throw Pillows: Two 21" x 21"  
Shown With Optional "Weltless Double Needle" Application - Must Specify

Options Shown:  
97: 41" Depth  
LS: Left Arm Sofa  
RN: Right Arm Corner Sofa  
TF: Track Front Arm  
B: Box (Loose) Back  
L: Large Tapered Leg



## 96LL-TFBL Left Arm Loveseat

57w 38d 37h  
Standard With One 21" Throw Pillow

## 96CC-XBL Curved Corner

38w 38d 37h  
Standard With Two 21" Throw Pillow

Options Shown:  
TF: Track Front Arm  
B: Box (Loose) Back  
L: Large Tapered Leg

## 96AC-XBL Armless Chair

24w 38d 37h

## 96RL-TFBL Right Arm Loveseat

57w 38d 37h  
Standard With One 21" Throw Pillow



## 96LS-RKS Left Arm Sofa

79w 22d 37h  
25AH 38OD 19SH  
Standard Throw Pillows: One 21" x 21"

## 96RL-RKS Right Arm Loveseat

57w 22d 37h  
25AH 38OD 19SH  
Standard Throw Pillows: One 21" x 21"

Options Shown:  
96: 38" Depth  
LS: Left Arm Sofa  
CC: Curved Corner  
RL: Right Arm Loveseat  
SO: Sectional Ottoman  
R: Rolled Arm  
K: Knife (Loose) Back  
S: Skirt

## 96CC-XKS Curved Corner

72w 22d 37h  
38OD 19SH  
Standard Throw Pillows: 2

## 96SO-XXS Sectional Ottoman

29w 29d 19h  
Standard With Rollers When Skirted



## 97LL-CFCU Left Arm Loveseat

57w 41d 39h  
Standard with One 21" Throw Pillow

## 97RZ-CFCU Right Arm Chaise

34w 66d 39h  
Standard with One 21" Throw Pillow

Options Shown:  
CF: Crescent Front Arm  
C: Casual (Loose) Back  
U: Upholstered Base



Note: All dimensions are approximate and will vary slightly based on options.

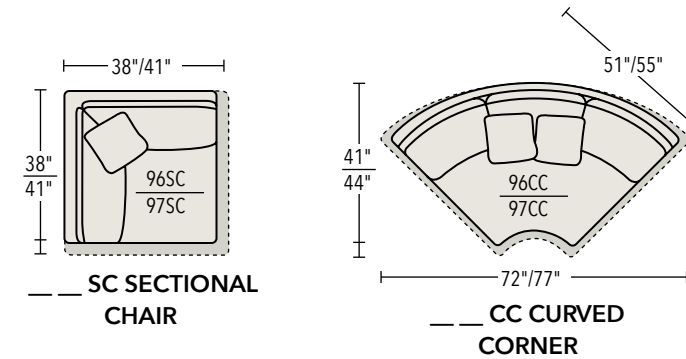
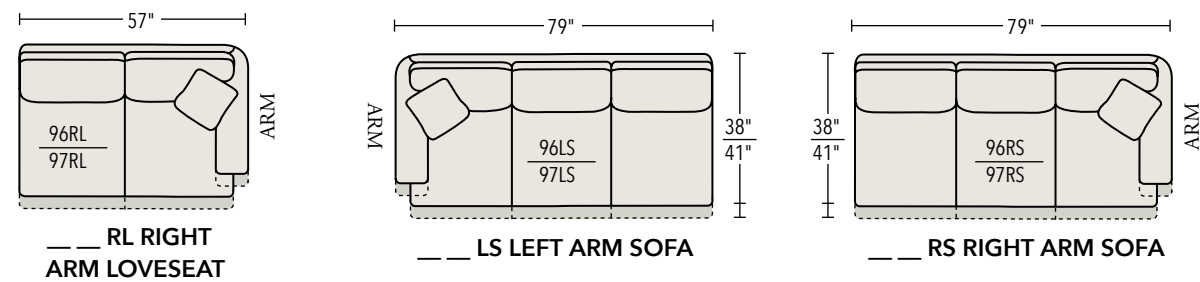
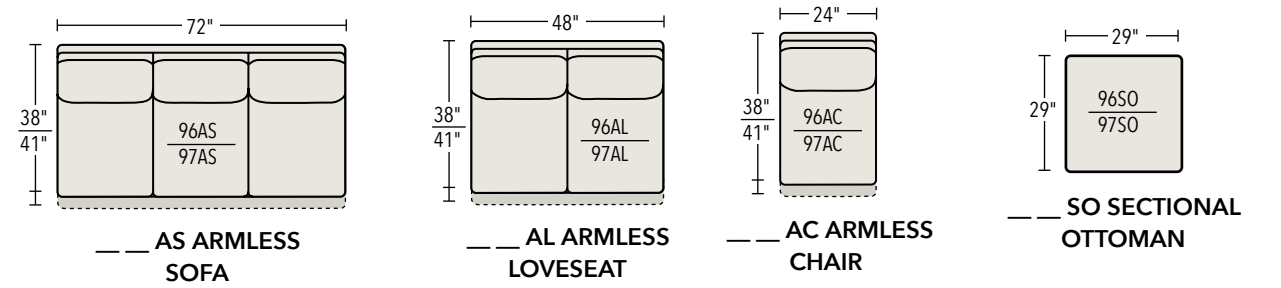
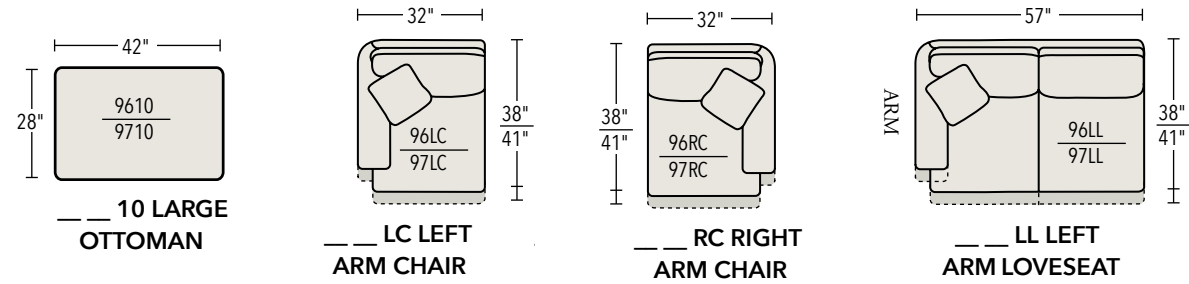
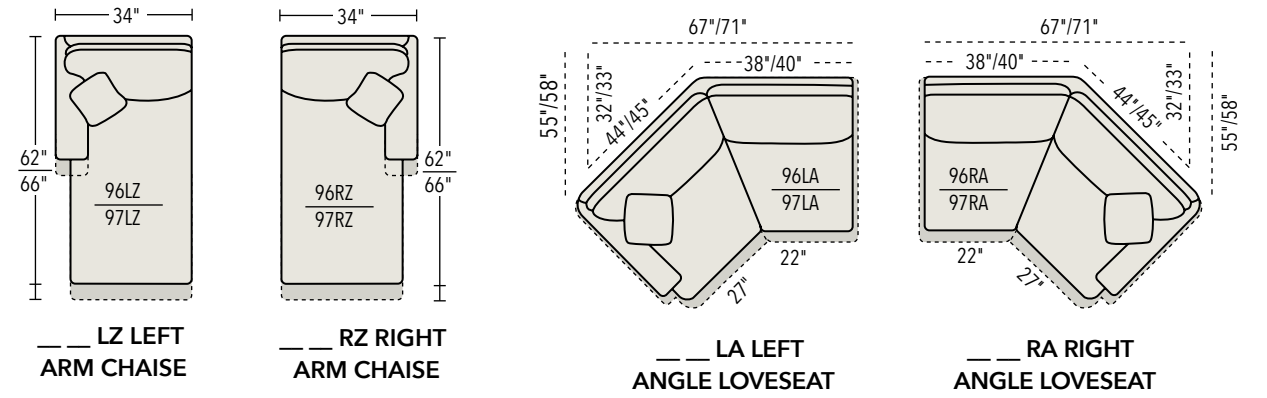
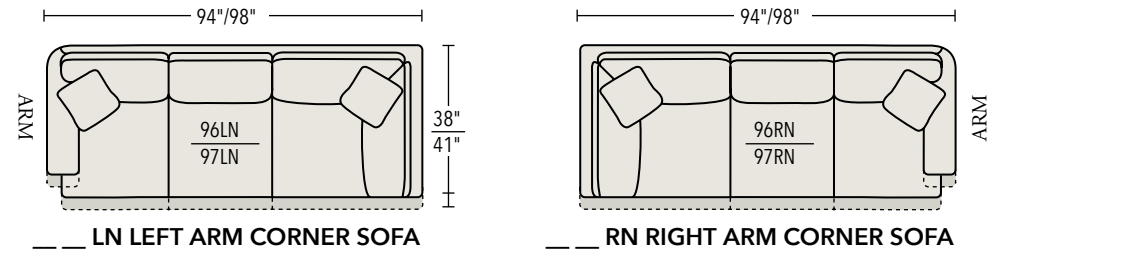
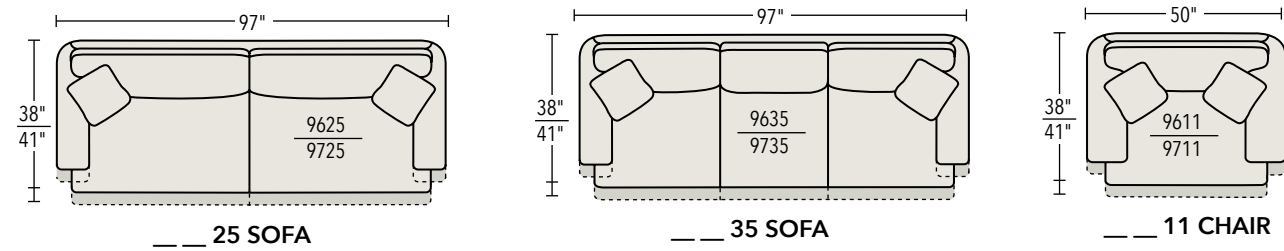
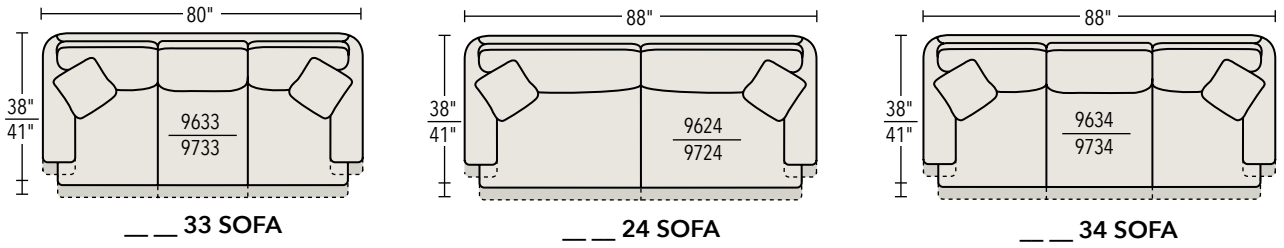
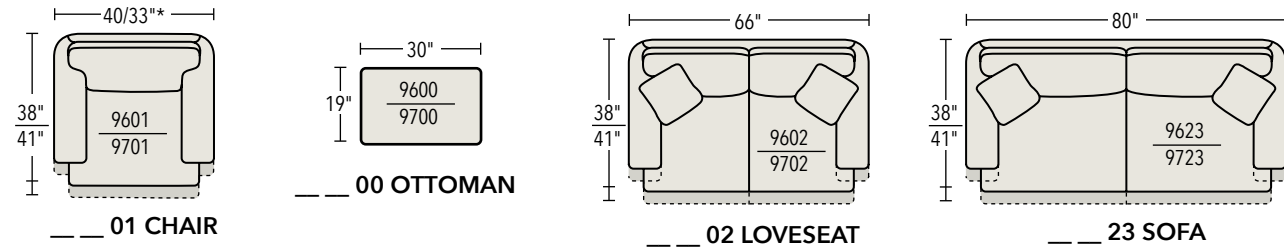



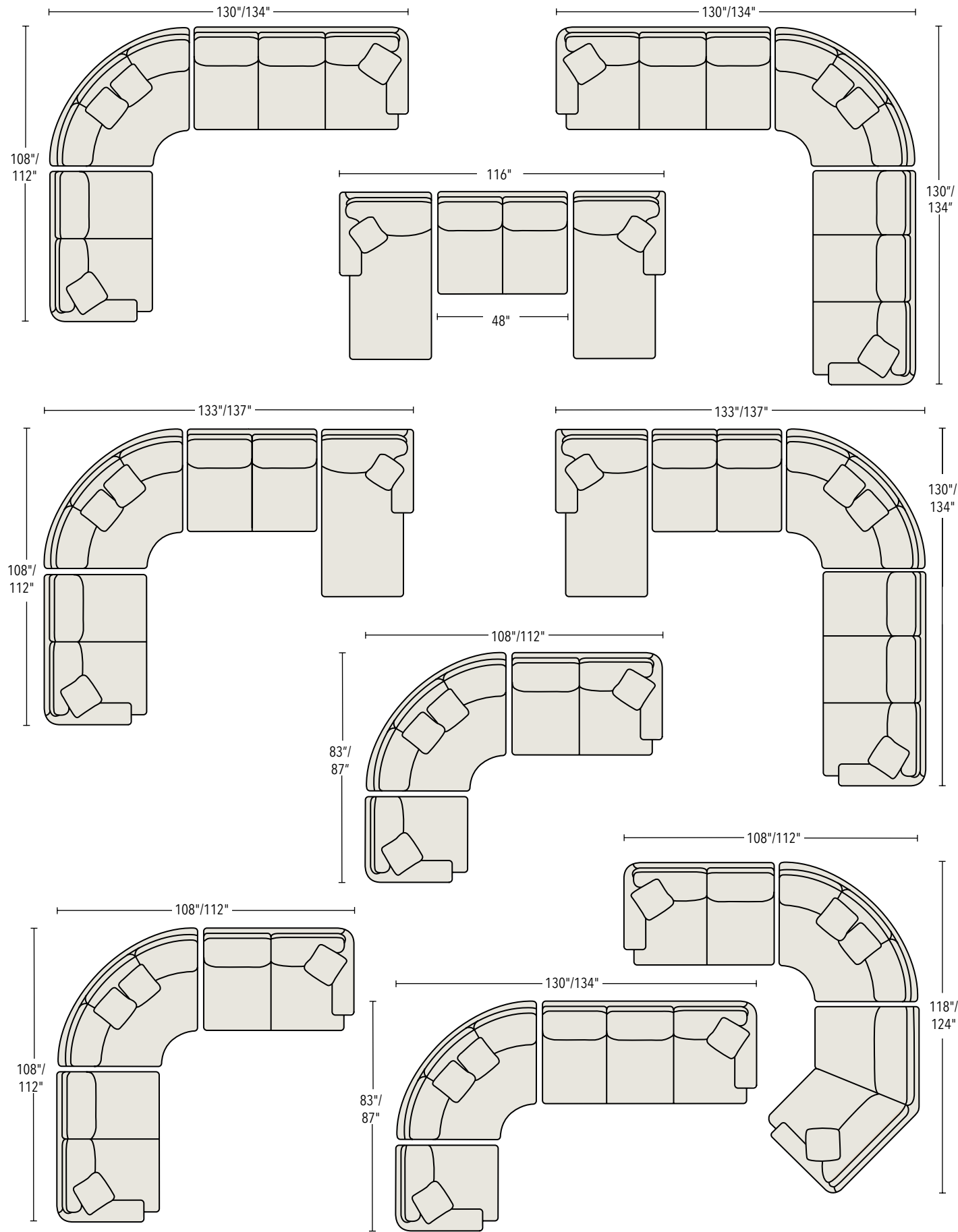

Scale 1/4" = 1'

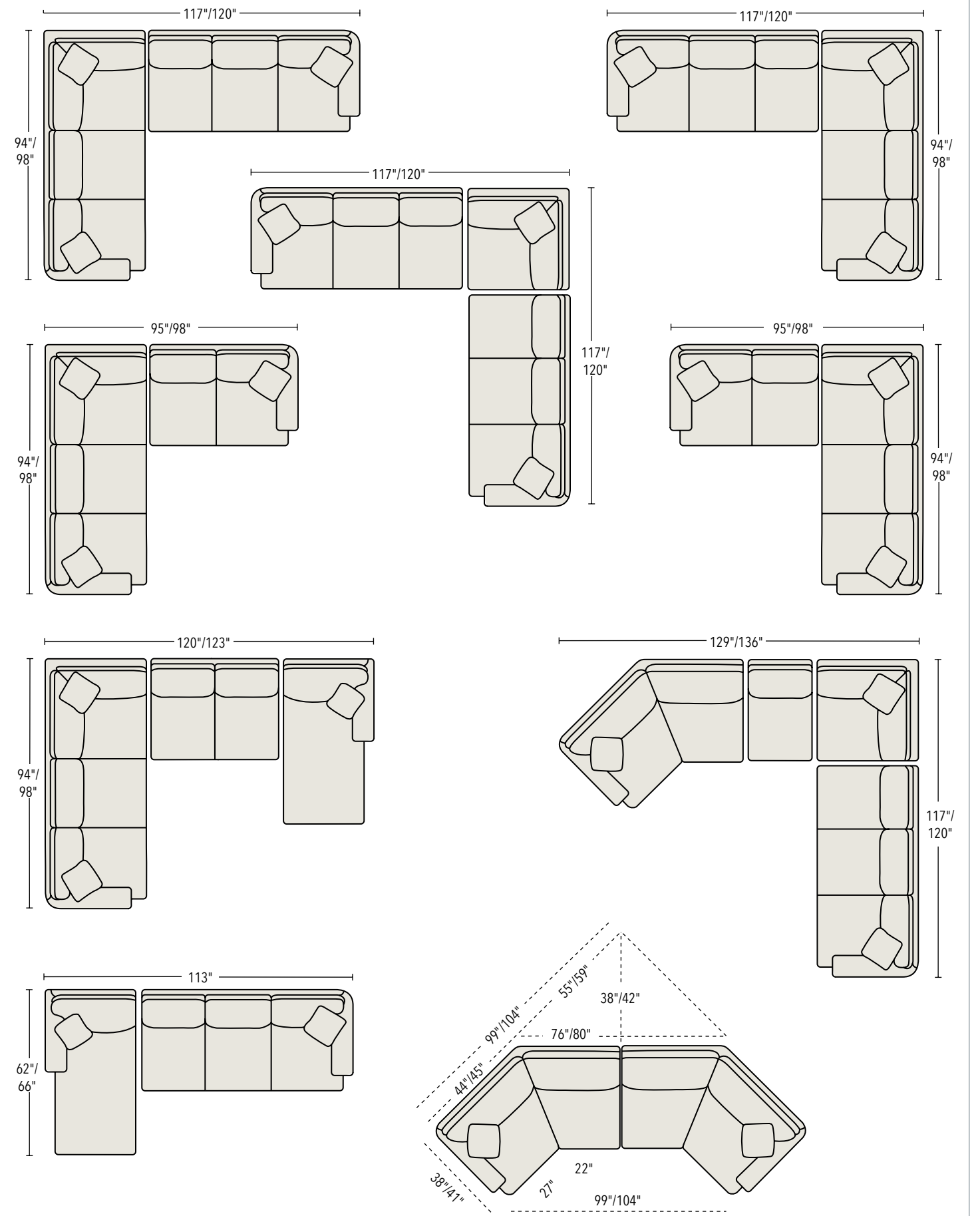

Scale 1/4" = 1'





# Sherrill Your Way

At Sherrill, we make it easy to custom create your own larger scaled sofa, loveseat, sectional, chair, and ottoman with 5 arm styles and 2 base options.



## 9801-T(NS) Chair

48w 23d 39h  
Standard Throw Pillow: 1  
Shown with Optional #1-P Nails.  
T = Track Arm  
NS = No Skirt

## 9800-NS Ottoman

34w 25d 18h  
Standard with Rollers  
Shown with Optional #1-P Nails.  
NS = No Skirt



1750-1 Chair  
9892-R Sofa  
1578-1 Lounge Chair  
245-930 Fox Hollow Lamp Table  
969-486 Castel Hex Accent Table  
245-840 Fox Hollow Cocktail Table



# Sherrill Your Way Series

Choose from 5 arm styles, 2 base options, 2 nail options, 2 cushion Fill options, and an amazing assortment of program fabrics to custom create your perfect sofa, loveseat, sectional, chair, and ottoman.

## 1 Select Your Frame Style

All styles standard with Kick Pleat Skirt. Omit Skirt on all styles-No Charge. Must specify "NS" = No Skirt Sketches shown in 1/4" scale

### Chairs / Sofas:

- 9801 - Chair
- 9800 - Ottoman
- 9842 - Loveseat
- 9892 - Sofa

### Sectional Pieces:

- 9860 - Right Arm Loveseat
- 9861 - Left Arm Loveseat
- 9862 - Right Arm Sofa
- 9863 - Left Arm Sofa
- 9864 - Right Arm Corner Sofa
- 9865 - Left Arm Corner Sofa
- 9866 - Right Arm Chaise
- 9867 - Left Arm Chaise

### Standard Construction

Eight-Way Hand Tied  
 Loose Pillow Back / Kick Pleat Skirt = 8 1/4 in.  
 Height: 39 in.  
 Overall Depth: 42 in.  
 Seat Depth: 23 in.  
 Arm Height: 27 in. Seat Height: 20 in.  
 Standard Finish: Brown Mahogany  
 Standard Throw Pillows are 22" x 22"  
 All dimensions are approximate.

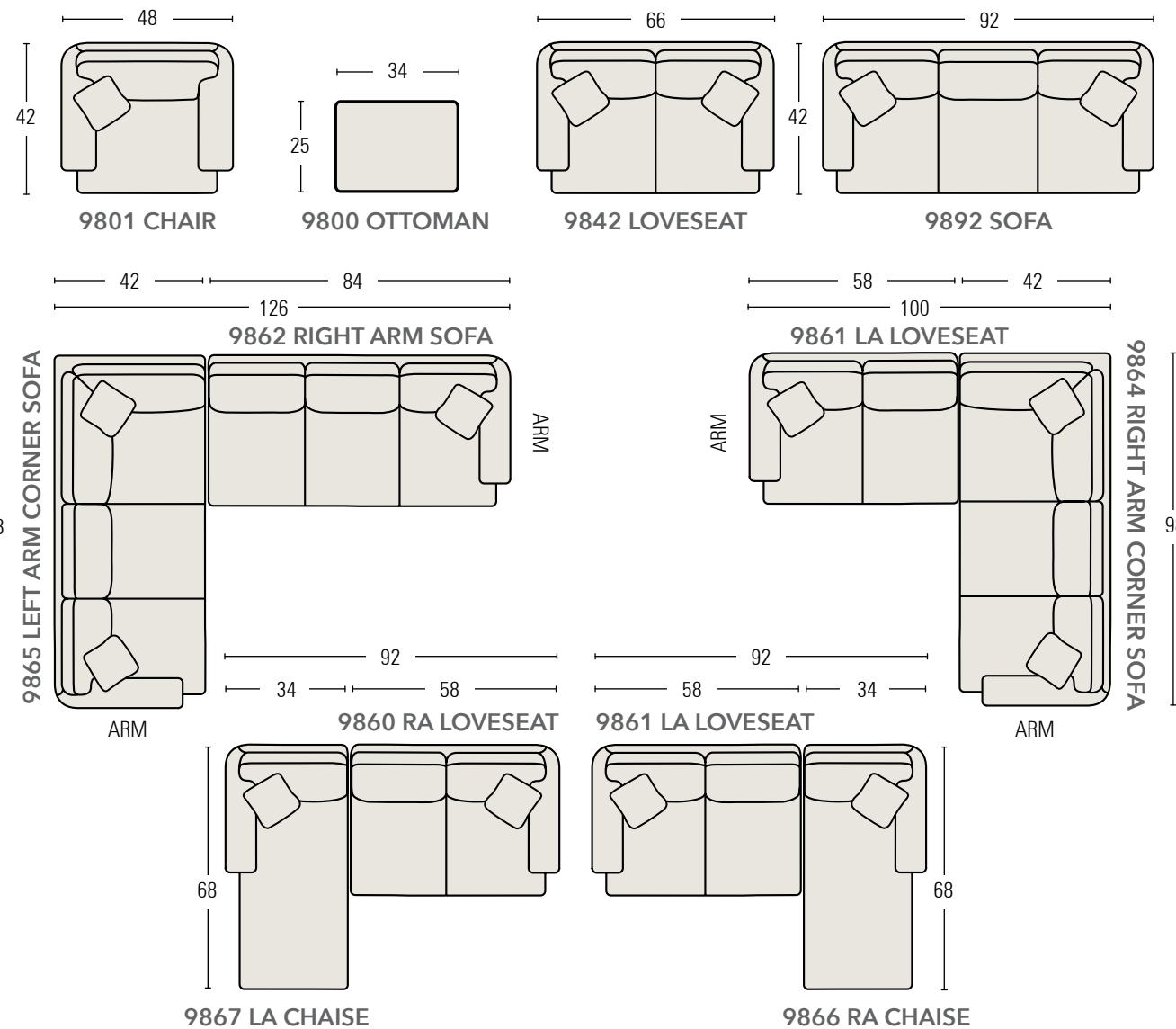

## 2 Select Your Arm Style



E = English Arm



P = Pleated Arm



R = Rolled Arm

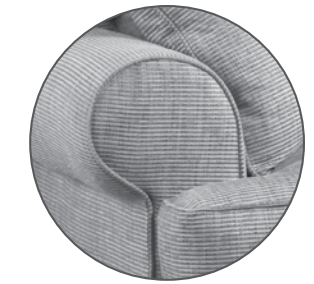

S = Sock Arm



T = Track Arm



### 9842-R (NS) Loveseat

66w 42d 39h  
 Options Shown:  
 R: Rolled Arm  
 NS: No Skirt

## 3 Select Your Base Style

All styles standard with Kick Pleat Skirt. Omit skirt on all styles-No Charge. Must specify "NS" = No Skirt



### 9892-R Sofa

92w 42d 39h  
 Options Shown:  
 R: Rolled Arm



### 9892-R (NS) Sofa

92w 42d 39h  
 Options Shown:  
 R: Rolled Arm  
 NS: No Skirt



## 9801-E (NS) Chair

48w 42d 39h  
 Inside: 36w 23d 19h  
 Arm Height: 27 Seat Height: 20  
 Loose Pillow Back  
 Standard Throw Pillows: One 21" x 21"



Options Shown:  
 E = English Arm  
 NS = No Skirt



## 9892-T (NS) SOFA

92w 42d 39h  
 Inside: 79w 23d 22h  
 Options Shown:  
 T: Track Arm  
 NS: No Skirt  
 Standard Throw Pillows: 2



## 9863-T (NS) Left Arm Sofa

84w 42d 39h  
 Options Shown:  
 T: Track Arm  
 NS: No Skirt  
 Standard Throw Pillows: 1  
 Shown With Optional #1-FN Nails On Arms  
 No Nails Standard



## 9864-T (NS) Right Arm Corner Sofa

98w 42d 39h  
 Options Shown:  
 T: Track Arm  
 NS: No Skirt  
 Standard Throw Pillows: 2  
 Shown With Optional #1-FN Nails On Arms  
 No Nails Standard

Also Available:  
 9862-T (NS) Right Arm Sofa  
 9865-T (NS) Left Arm Corner Sofa



## 9801-P Chair

48w 42d 39h  
 Inside: 36w 23d 19h  
 Arm Height: 27 Seat Height: 20  
 Options Shown:  
 P: Pleated Arm  
 Standard Throw Pillow: 1

## 9800 Ottoman

18w 34d 25h  
 Standard With Rollers



## 9892-S Sofa

92w 42d 39h  
 Inside: 70w 23d 22h  
 Options Shown:  
 S: Sock Arm  
 Standard Throw Pillows: 2



Also Available:  
 9862 Right Arm Sofa  
 9867 Left Arm Chaise

## 9863-R Left Arm Sofa

84w 42d 39h  
 Options Shown:  
 R: Rolled Arm  
 Standard Throw Pillows: 1

## 9866-R Right Arm Chaise

34w 68d 39h  
 50SD  
 Options Shown:  
 R: Rolled Arm  
 Standard Throw Pillows: 1





# 2 Series Design Choices

Creating your own personal upholstery has never been easier than with the moderately scaled 2 Series. Select a frame profile, then complete your design by choosing arm back and base options that suit your style.

## 2F92-TCLT SOFA

### Options Shown:

- 2: 2 Series
- F: Arm To The Front
- T: Track Arm
- CL: Casual Loose
- T: Tapered Leg

## 2T11-NKLD Chair

### Options Shown:

- 2: 2 Series
- T: T-Cushion
- 11: Chair
- N: Nailed Arm
- KL: Knife Loose Back
- D: Dressmaker Skirt

- 2F92-TCLT Sofa
- 2T11-NKLD Chair
- 251-970 Bennett Drawer End Table
- 251-950 Bennett Square End Table
- 251-840 Bennett Rectangle Cocktail Table







# 2 Series Design Your Own

Creating your own personal upholstery has never been easier than with the moderately scaled 2 Series. First select a frame profile: "T"-cushion or "F"-cushion for your sofa, chair, or sectional. Then complete your design by choosing arm, back, and base options that suit your style.

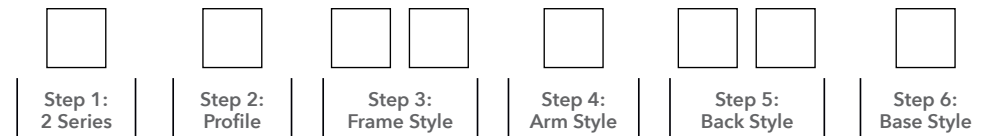

1 Select 2 Series — 2-□-□-□-□-□-□-□

2 Select Frame Profile — 2-■-□-□-□-□-□-□  
Select T for T Cushion Profile or F for Arm To The Front Profile



T = T CUSHION PROFILE  
Shown: 2T11-SBAT



F = ARM TO THE FRONT PROFILE  
Shown: 2F11-NBAT

3 Select Your Frame Style — 2-□-■-■-□-□-□-□

Note: All dimensions are approximate and will vary slightly based on options.  
Note: T-Track Arm reduces standard chair and sofa widths by 6" and each 1 Armed Sectional Piece by 3".

### Chairs / Sofas:

- 11 - Chair
- 00 - Ottoman
- 62 - Two Cushion 62" Loveseat
- 72 - Two Cushion 72" Sofa
- 73 - Three Cushion 72" Sofa
- 82 - Two Cushion 82" Sofa
- 83 - Three Cushion 82" Sofa
- 92 - Two Cushion 92" Sofa
- 93 - Three Cushion 92" Sofa

### Sectional Pieces:

- LL - Left Arm Loveseat
- RL - Right Arm Loveseat
- LS - Left Arm Sofa
- RS - Right Arm Sofa
- LN - Left Arm Corner Sofa
- RN - Right Arm Corner Sofa

### Standard Construction

Height: 36 in.  
Seat Depth: 20 in.  
Arm Height: 25 in.  
Overall Depth: 35 in.  
Standard Finish: Brown Mahogany  
Chairs with skirts are available with optional swivel/swivel rocker base for an upcharge.  
Standard Throw Pillows Are 21"x21"

4 Select Your Arm Style — 2-□-□-□-■-□-□-□

\*T Arm reduces width by approx. 3" per arm. #1-FN is the standard nail on the "N" ARM. Any color #1 nail is available on "N" Arm at no additional charge.  
Example: 2T83-RBAD = 2 series, T style, 82" sofa, 3 cushions, Rolled arm, Box Attached back, Dressmaker skirt

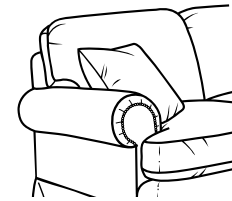

N- Nailed \*



P- Pleated



R- Rolled



S- Sock



T- Track \*

5 Select Your Back Style — 2-□-□-□-□-■-■-□

\*\*CL-Casual back is only available loose.



BA- Box Attached



BL- Box Loose



KA- Knife Attached



KL- Knife Loose



CL- Casual Loose \*\*

6 Select Your Base Style — 2-□-□-□-□-□-□-■

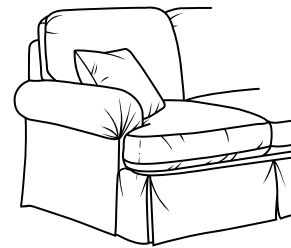

D- Dressmaker

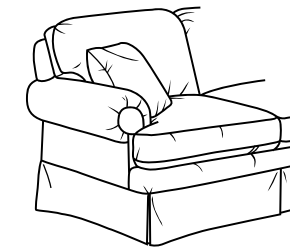

S- Skirt

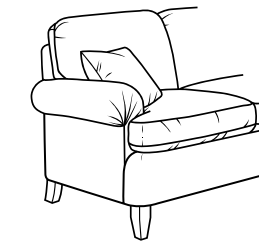

T- Tapered

### T-Track Arm Option

Reduces overall width on all 2 Series upholstery styles by approx. 3" per Arm.  
The inside width remains the same on all 2-Series upholstery styles regardless of selected arm option.



2F11-TBAT Chair

30w 36h  
Inside 20w



Options Shown:  
2: 2 Series  
F: Arm To The Front  
11: Chair  
T: Track Arm  
BA: Box Attached Back  
S: Skirt

### 2F11-PBAS Chair

36w 36h  
Inside 20w  
Options Shown:  
2: 2 Series  
F: Arm To The Front  
11: Chair  
P: Pleated Arm  
BA: Box Attached Back  
S: Skirt

### 2X00-XXS Ottoman

25w 22d 18h  
Standard With Casters With  
S-Skirt Or D-Dressmaker



223-940 Corbel Lamp Table  
80P-42D Cocktail Table

## 2FLN-TBLT Left Arm Corner Sofa

Options Shown:

2: 2 Series  
F: Arm To The Front  
LN: Left Arm Corner Sofa  
T: Track Arm  
BL: Box Loose  
T: Tapered Leg

## 2FRS-TBLT Right Arm Sofa

Options Shown:

2: 2 Series  
F: Arm To The Front  
RS: Right Arm Sofa  
T: Track Arm  
BL: Box Loose  
T: Tapered Leg





**2F11-SCLD Chair**

36w 20od 20sd 36h  
 Options Shown:  
 2: 2 Series  
 F: Arm To The Front  
 11: Chair  
 S: Sock Arm  
 CL: Casual Loose Back  
 D: Dressmaker

**2F11-NBAT Chair**

36w 35od 20sd 36h  
 Options Shown:  
 2: 2 Series  
 F: Arm To The Front  
 11: Chair  
 N: Nailed Arm\*  
 BA: Box Attached Back  
 T: Tapered Leg

\*Nailed Arm is standard with #1-FN nail.  
 Also available in any color of size #1 nail.

**2T11-PKLD Chair**

36w 35od 20sd 36h  
 Options Shown:  
 2: 2 Series  
 F: Arm To The Front  
 11: Chair  
 P: Pleated Arm  
 KL: Knife Loose Back  
 D: Dressmaker

**2F11-RBLS Chair**

36w 35od 20sd 36h  
 Options Shown:  
 2: 2 Series  
 F: Arm To The Front  
 11: Chair  
 R: Rolled Arm  
 BL: Box Loose Back  
 S: Skirt

**2T62-RKAS 62" Loveseat**

62w 35od 20sd 36h  
 Options Shown:  
 2: 2 Series  
 T: T-Cushion  
 62: 62" Loveseat  
 R: Rolled Arm  
 KA: Knife Attached Back  
 S: Skirt

**2F72-PBLT 72" Sofa**

72w 35od 20sd 36h  
 Options Shown:  
 2: 2 Series  
 F: Arm To The Front  
 72: 72" 2-Cushion Sofa  
 P: Pleated Arm  
 BL: Box Lose Back  
 T: Tapered Leg

**2F82-TBAD 82" Two Cushion Sofa**

82/76w\* 35od 20sd 36h  
 Options Shown:  
 2: 2 Series  
 F: Arm To The Front  
 82: 82" 2-Cushion Sofa\*  
 T: Track Arm  
 BA: Box Attached Back  
 D: Dressmaker  
 Shown With Optional  
 "Weltless French Seam"  
 Standard With Welt

Track Arm Option  
 Reduces Actual Width To 76"

**2T93-NKLS 92" Three Cushion Sofa**

92w 35od 20sd 36h  
 Options Shown:  
 2: 2 Series  
 T: T-Cushion  
 93: 92" 3-Cushion Sofa  
 N: Nailed Arm  
 KL: Knife Loose Back  
 S: Skirt







**2F62-SBAT Loveseat**

Options Shown:

2: 2 Series

F: Arm To The Front

62: 62" Loveseat

S: Sock Arm

BA: Box Attached

Back

T: Tapered Leg



**2TLS-TCLT Left Arm Sofa**

87w\* 35od 20sd 36h

Options Shown:

2: 2 Series

T: T-Cushion

LS: Left Arm Sofa

T: Track Arm

CL: Casual Loose Back

T: Tapered Leg Base

\*Note: Track Arm Option Reduces Actual Width To 84"

**2TRN-TCLT Right Arm Corner Sofa**

95w\* 35od 20sd 36h

Options Shown:

2: 2 Series

T: T-Cushion

RN: Right Arm Corner Sofa

T: Track Arm

CL: Casual Loose Back

T: Tapered Leg Base

\*Note: Track Arm Option Reduces Actual Width To 92"

Available Sectional Pieces

Note: All dimensions are approximate and will vary slightly based on options.

Note: T-Track Arm reduces standard chair and sofa widths by 6" and each 1 armed sectional pieces by 3".

Sketches shown in 1/4" scale.

Note: All dimensions are approximate and will vary slightly based on options.  
 Note: T-Track Arm reduces standard chair and sofa widths by 6" and each 1 armed sectional pieces by 3".  
 Sketches shown in 1/4" scale.

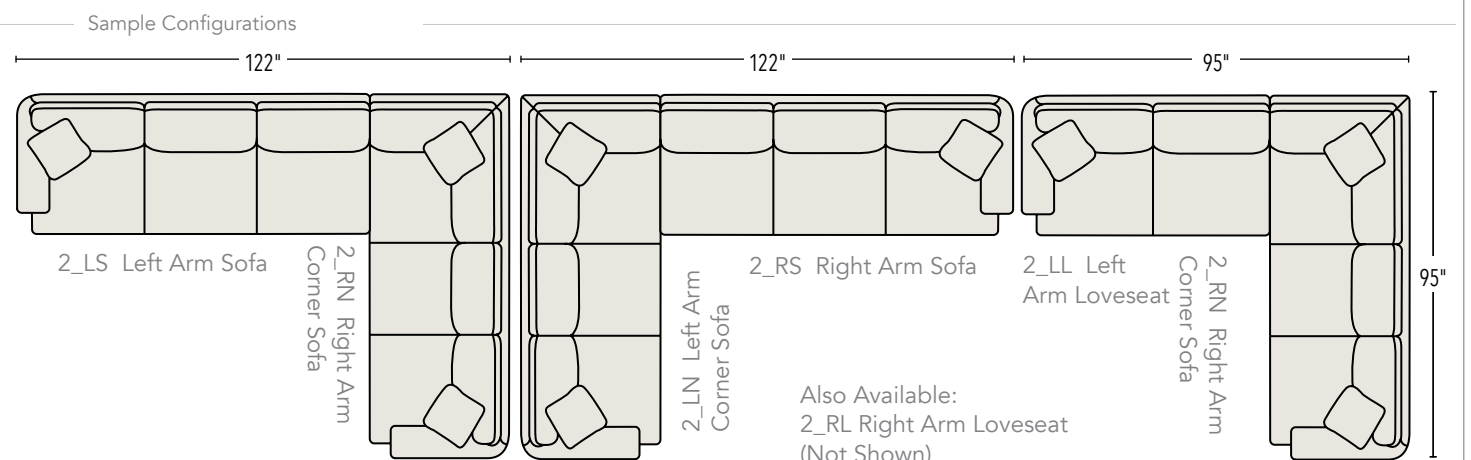
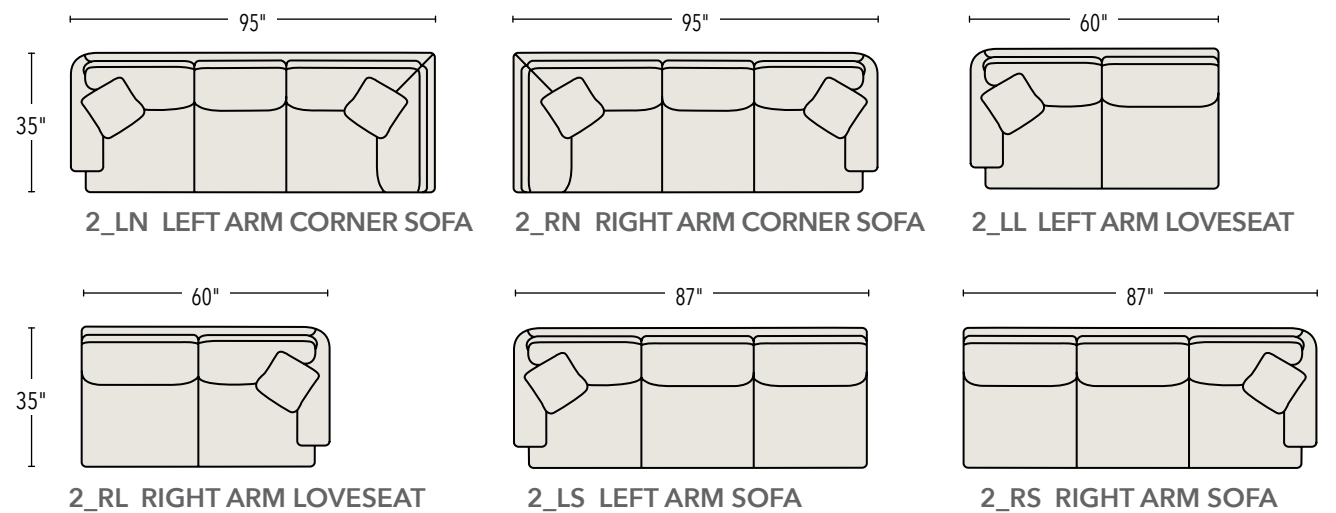
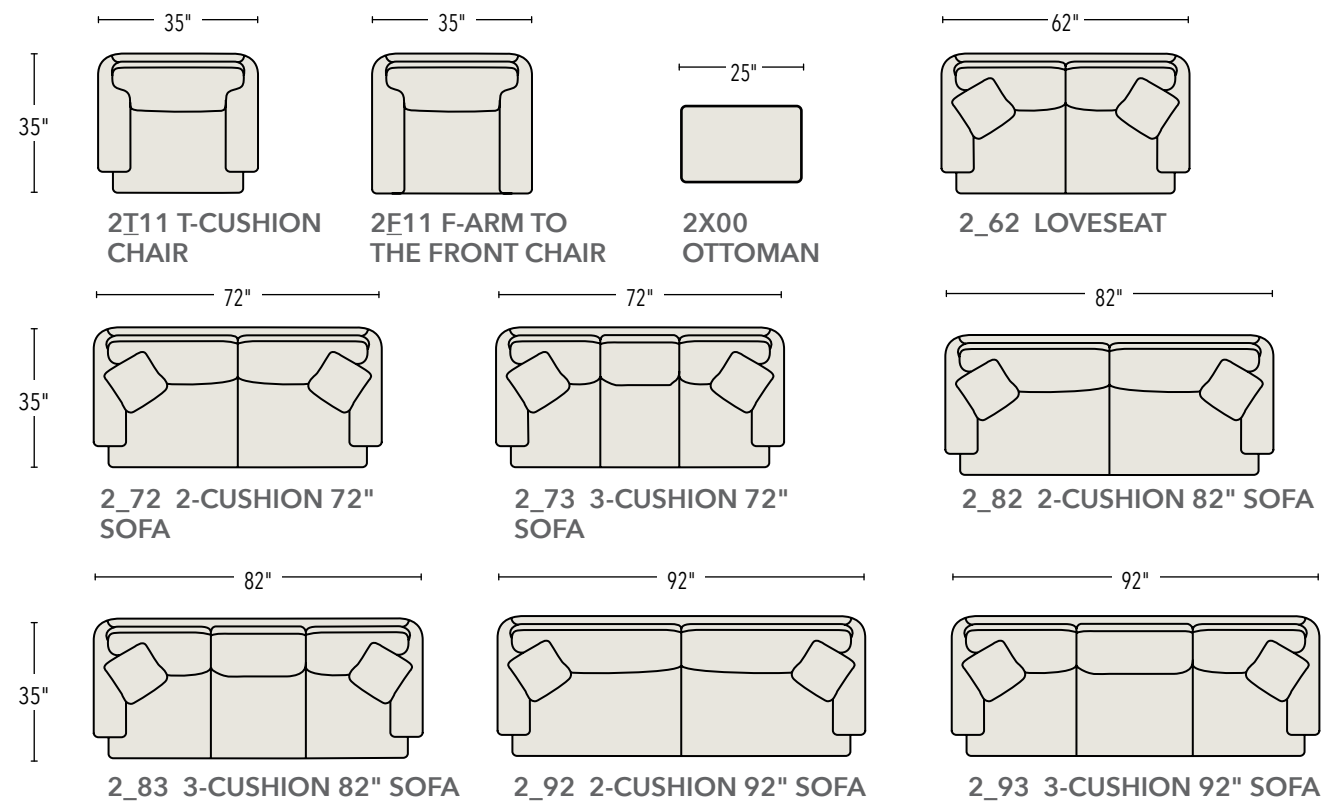

Also Available:  
 2\_RL Right Arm Loveseat  
 (Not Shown)





**2T11RBAS**

36w 35d 36h  
 Inside: 52w 20d 17h  
 Options Shown:  
 2: 2 Series  
 T: T Cushion  
 11: Chair  
 R: Rolled Arm  
 BA: Box Attached Back  
 S: Skirt



**2T62SBAT**

62w 35d 36h  
 Inside: 67w 20d 17h  
 Finish Shown: Carob Brown  
 Options Shown:  
 2: 2 Series  
 T: T Cushion  
 62: 62" Loveseat  
 S: Sock Arm  
 BA: Box Attached Back  
 T: Tapered Leg



**2F11TCLT**

30w 35d 36h  
 Finish Shown: Carob Brown  
 Options Shown:  
 2: 2 Series  
 F: Arm To Front  
 11: Chair  
 T: Track Arm  
 CL: Casual Loose Back  
 T: Tapered Leg



**2F72SBLT**

72w 35d 36h  
 Arm Height: 25 Seat Height: 19  
 Finish Shown: Carob Brown  
 Options Shown:  
 2: 2 Series  
 F: Arm To Front  
 72: 72" 2 Cushion Sofa  
 S: Sock Arm  
 BL: Box Loose Back  
 T: Tapered Leg



**2T93TBLT**

92/86w\* 35d 36h  
 Inside: 71w 20d 17h  
 Finish Shown: Carob Brown  
 Options Shown:  
 2: 2 Series  
 T: T Cushion  
 93: 92" 3 Cushion Sofa  
 T: Track Arm  
 BL: Box Loose Back  
 T: Tapered Leg



\*Track Arm  
 Reduces Actual  
 Width To 86"



**2T72NKLS**

72w 35d 36h  
 Inside: 52w 20d 17h  
 Arm Height: 25 Seat Height: 19  
 Options Shown:  
 2: 2 Series  
 T: T Cushion  
 72: 72" 2 Cushion Sofa  
 N: Nailed Arm  
 KL: Knife Loose Back  
 S: Skirt



**2F72SCLD**

35w 35d 36h  
 Options Shown:  
 2: 2 Series  
 F: Arm To Front  
 72: 72" 2 Cushion Sofa  
 S: Sock Arm  
 CL: Casual Loose Back  
 D: Dressmaker Skirt



**2F82TBLT**

82/76w\* 35d 36h  
 Finish Shown: Carob Brown  
 Options Shown:  
 2: 2 Series  
 F: Arm To Front  
 82: 82" 2 Cushion Sofa  
 T: Track Arm  
 BL: Box Loose Back  
 T: Tapered Leg



\*Track Arm  
 Reduces Actual  
 Width To 76"





# 6 Series Design Your Own

*Surround yourself in  
total comfort...*

The 6 Series is the ultimate opportunity to create your own personal one-of-a-kind, sophisticated-casual statement of luxury seating.

Generous in scale and uncompromising in comfort, the 6 Series custom frame options allow you to build your own chair or sofa frame style. Choose the size, number of back and seat cushions, as well as your choice of three arm styles.

Add to that the tremendous assortment of Sherrill custom fabrics and finishes, as well as C.O.M., and the opportunities are seemingly endless.



**MH23329-90 Fairchild  
Center Table**

**61-LACS Left Arm  
Corner Sofa**

**61-RAS Right Arm Sofa**

**Options Shown:**

**61: Rising Arm**

**Finish Shown: Slate**

**60-SO-R Sectional Ottoman**

**Options Shown:**

**Standard With Roller**



# 6 Series Design Your Own

Create your own personalized upholstery with the 6 Series.

Choose your arm style, number of back and seat cushions, as well as the perfect length for your custom sofa.

6 SERIES | ARM STYLE | BACKS SEATS | SOFA LENGTH

Standards:  
 Loose Pillow Back  
 H36 SD23 AH24 OD41  
 Approx. Seat Height: 17  
 Standard Finish: Black Nickel  
 Standard Throw Pillows: Sofas 4 - 24 x 24"; Chairs: 1 - 21 x 21"



61 RISING ARM	# BACK / SEAT CUSHIONS	SOFA LENGTHS"
6121 = (61) Rising Arm	(2) Backs / (1) Seat	86 - 96 - 106"
6122 = (61) Rising Arm	(2) Backs / (2) Seat	86 - 96 - 106"
6131 = (61) Rising Arm	(3) Backs / (1) Seat	86 - 96 - 106"
6133 = (61) Rising Arm	(3) Backs / (3) Seat	86 - 96 - 106"
6101 = (61) Rising Arm Chair		



62 SCOOP ARM	# BACK / SEAT CUSHIONS	SOFA LENGTHS"
6221 = (62) Scoop Arm	(2) Backs / (1) Seat	86 - 96 - 106"
6222 = (62) Scoop Arm	(2) Backs / (2) Seat	86 - 96 - 106"
6231 = (62) Scoop Arm	(3) Backs / (1) Seat	86 - 96 - 106"
6233 = (62) Scoop Arm	(3) Backs / (3) Seat	86 - 96 - 106"
6201 = (62) Scoop Arm Chair		



63 TRACK ARM	# BACK / SEAT CUSHIONS	SOFA LENGTHS"
6321 = (63) Track Arm	(2) Backs / (1) Seat	86 - 96 - 106"
6322 = (63) Track Arm	(2) Backs / (2) Seat	86 - 96 - 106"
6331 = (63) Track Arm	(3) Backs / (1) Seat	86 - 96 - 106"
6333 = (63) Track Arm	(3) Backs / (3) Seat	86 - 96 - 106"
6301 = (63) Track Arm Chair		

Frame Styles Shown in 1/4" scale.

46" 37" 30"

41" 37" 30"

-- 01 46" CHAIR    60-SO 37" SECTIONAL OTTOMAN    60-OT 30" OTTOMAN

Ottomans available with  
 -W = Wood Foot or  
 -R = Rollers  
 MUST SPECIFY

86" 86" 86"

41" 41" 41"

-- 21-86 2 BACK / 1 SEAT 86" SOFA    -- 22-86 2 BACK / 2 SEAT 86" SOFA    -- 31-86 3 BACK / 1 SEAT 86" SOFA

1 SELECT ARM STYLE    2 SELECT # OF BACKS AND # OF SEATS    3 SELECT SOFA LENGTH

86" 96" 96"

41" 41" 41"

-- 33-86 3 BACK / 3 SEAT 86" SOFA    -- 21-96 2 BACK / 1 SEAT 96" SOFA    -- 22-96 2 BACK / 2 SEAT 96" SOFA

96" 96" 106"

41" 41" 41"

-- 31-96 3 BACK / 1 SEAT 96" SOFA    -- 33-96 3 BACK / 3 SEAT 96" SOFA    -- 21-06 2 BACK / 1 SEAT 106" SOFA

106" 106" 106"

41" 41" 41"

-- 22-06 2 BACK / 2 SEAT 106" SOFA    -- 31-06 3 BACK / 1 SEAT 106" SOFA    -- 33-06 3 BACK / 3 SEAT 106" SOFA

41" 41" 69" 69" 30" 60"

41" 41" 41" 41" 41" 41"

LC-LEFT ARM CHAIR    RC-RIGHT ARM CHAIR    LAL-LEFT ARM LOVESEAT    RAL-RIGHT ARM LOVESEAT    AC-ARMLESS CHAIR    AL-Armless Loveseat

99" 99" 41"

41" 41" 41"

-- LAS 99" LEFT ARM SOFA    -- RAS 99" RIGHT ARM SOFA    SC-Sectional Chair

109" 109"

41" 41" 41" 41"

-- LACS 109" LEFT ARM CORNER SOFA    -- RACS 109" RIGHT ARM CORNER SOFA





### 6101 Chair

46w 41d 36h  
 Inside: 30w 23d 19h  
 Arm Height: 24 Seat Height: 17  
 Loose Pillow Back  
 Standard Throw Pillows: One 21" x 21"  
 Finish Shown: Carob Brown  
 61: Rising Arm



### 6201 Chair

46w 41d 36h  
 Inside: 30w 23d 19h  
 Arm Height: 24 Seat Height: 17  
 Loose Pillow Back  
 Standard Throw Pillows: One 21" x 21"  
 Finish Shown: Carob Brown  
 62: Scoop Arm



### 6301 Chair

46w 41d 36h  
 Inside: 30w 23d 19h  
 Arm Height: 24 Seat Height: 17  
 Loose Pillow Back  
 Standard Throw Pillows: One 21" x 21"  
 Finish Shown: Carob Brown  
 63: Track Arm



### 60-OT-R Ottoman

30w 30d 17h  
 Seat Height: 17  
 Standard With Rollers



Also Available:

### 60-OT-W Ottoman

Standard With Wood Foot  
 Finish: Carob Brown

### 60-SO-R Sectional Ottoman

### 60-SO-W Sectional Ottoman

37w 37d 17h



6-Series Pieces Are Also Available in Leather



**6121-86 Sofa**

86w 41d 36h  
 Inside: 70w 23d 19h  
 Arm Height: 24 Seat Height: 17  
 Loose Pillow Back  
 Standard Throw Pillows: Two 21" x 21"  
 Two 24" x 24"  
 Finish Shown: Carob Brown



Options Shown:  
 61: Rising Arm  
 2: Backs  
 1: Seat  
 86: 86"

**6131-06 Sofa**

106w 41d 36h  
 Inside: 90w 23d 19h  
 Arm Height: 24 Seat Height: 17  
 Loose Pillow Back  
 Standard Throw Pillows  
 Two 21" x 21", Two 24" x 24"  
 Finish Shown: Carob Brown



Options Shown:  
 61: Rising Arm  
 3: Backs  
 1: Seat  
 06: 106"

**6133-06 Sofa**

106w 41d 36h  
 Inside: 90w 23d 19h  
 Arm Height: 24 Seat Height: 17  
 Loose Pillow Back  
 Standard Throw Pillows:  
 Two 21" x 21", Two 24" x 24"  
 Finish Shown: Carob Brown



Options Shown:  
 61: Rising Arm  
 3: Backs  
 3: Seat  
 06: 106"

**6221-06 Sofa**

106w 41d 36h  
 Inside: 90w 23d 19h  
 Arm Height: 24 Seat Height: 17  
 Loose Pillow Back  
 Standard Throw Pillows: Two 21" x 21"  
 Two 24" x 24"  
 Finish Shown: Carob Brown



Options Shown:  
 62: Scoop Arm  
 2: Backs  
 1: Seat  
 06: 106"

**6231-96 Sofa**

96w 41d 36h  
 Inside: 80w 23d 19h  
 Arm Height: 24 Seat Height: 17  
 Loose Pillow Back  
 Standard Throw Pillows: Two 21" x 21"  
 Two 24" x 24"  
 Finish Shown: Carob Brown



Options Shown:  
 62: Scoop Arm  
 3: Backs  
 1: Seat  
 96: 96"

**6233-96 Sofa**

96w 41d 36h  
 Inside: 80w 23d 19h  
 Arm Height: 24 Seat Height: 17  
 Loose Pillow Back  
 Standard Throw Pillows: Two 21" x 21"  
 Two 24" x 24"  
 Finish Shown: Carob Brown



Options Shown:  
 62: Scoop Arm  
 3: Backs  
 3: Seats  
 96: 96"





### 6321-96 Sofa

96w 41d 36h  
 Inside: 80w 23d 19h  
 Arm Height: 24 Seat Height: 17  
 Loose Pillow Back  
 Standard Throw Pillows: Two 21" x 21"  
 Two 24" x 24"  
 Finish Shown: Carob Brown  
 Options Shown:  
 63: Track Arm  
 2: Backs  
 1: Seat  
 96: 96"



### 6322-06 Sofa

106w 41d 36h  
 Inside: 90w 23d 19h  
 Arm Height: 24 Seat Height: 17  
 Loose Pillow Back  
 Standard Throw Pillows: Two 21" x 21"  
 Two 24" x 24"  
 Finish Shown: Carob Brown  
 Options Shown:  
 63: Track Arm  
 2: Backs  
 2: Seats  
 06: 106"



### 6331-86 Sofa

86w 41d 36h  
 Inside: 70w 23d 19h  
 Arm Height: 24 Seat Height: 17  
 Loose Pillow Back  
 Standard Throw Pillows: Two 21" x 21"  
 Two 24" x 24"  
 Finish Shown: Carob Brown  
 Options Shown:  
 63: Track Arm  
 3: Backs  
 1: Seat  
 86: 86"



MH23329-90 Fairchild Center Table  
 61-LACS Left Arm Corner Sofa  
 61-RAS Right Arm Corner Sofa





### 61 - Rising Arm

#### 61-LAS Left Arm Sofa

99w 41d 36h

#### 61-SC Sectional Chair

41w 41d 36h

#### 61-RAS Right Arm Sofa

99w 41d 36h

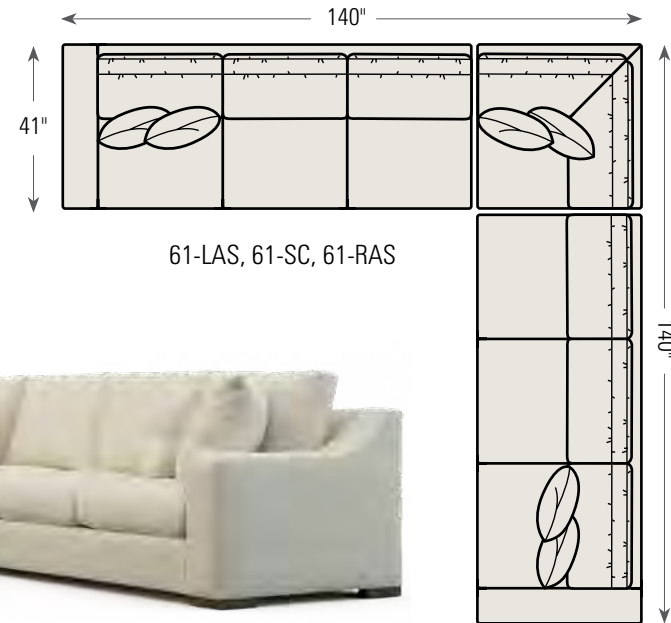

### 62 - Scoop Arm

#### 62-LACS Left Arm Corner Sofa

109w 41d 36h

#### 62-RAL Right Arm Loveseat

69w 41d 36h

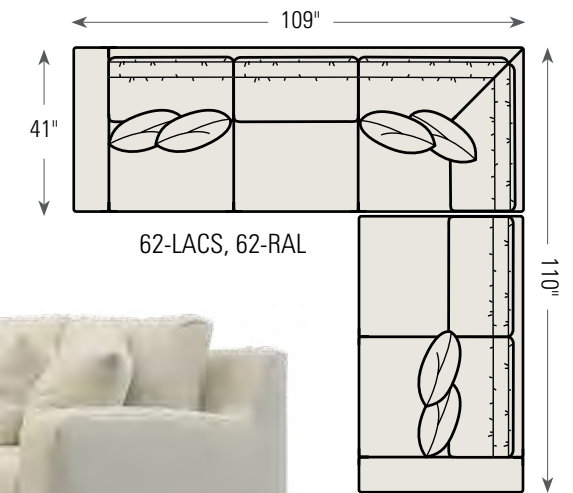

### 63 - Track Arm

#### 63-LAS Left Arm Sofa

99w 41d 36h

#### 63-SC Sectional Chair

41w 41d 36h

#### 63-RAS Right Arm Sofa

99w 41d 36h

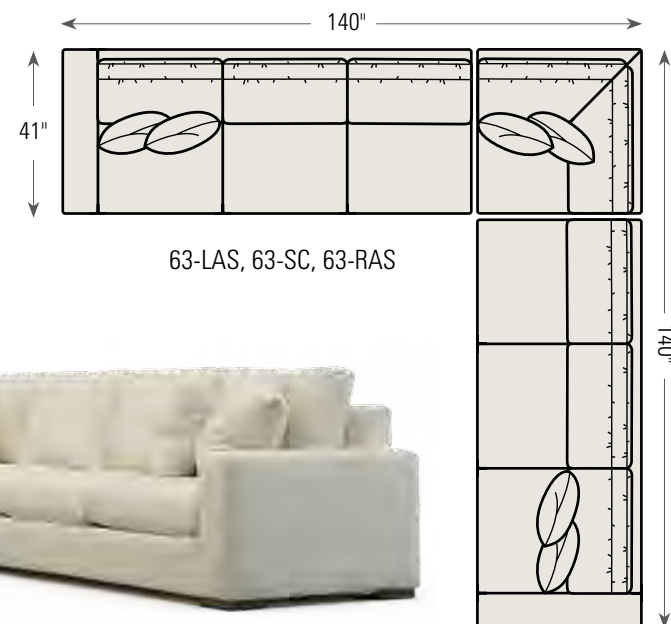

#### 62-LC Left Arm Chair

41w 41d 36h

#### 62-AC Armless Chairs

30w 41d 36h

#### 62-SC Sectional Chair

41w 41d 36h

#### 62-RC Right Arm Chairs

41w 41d 36h

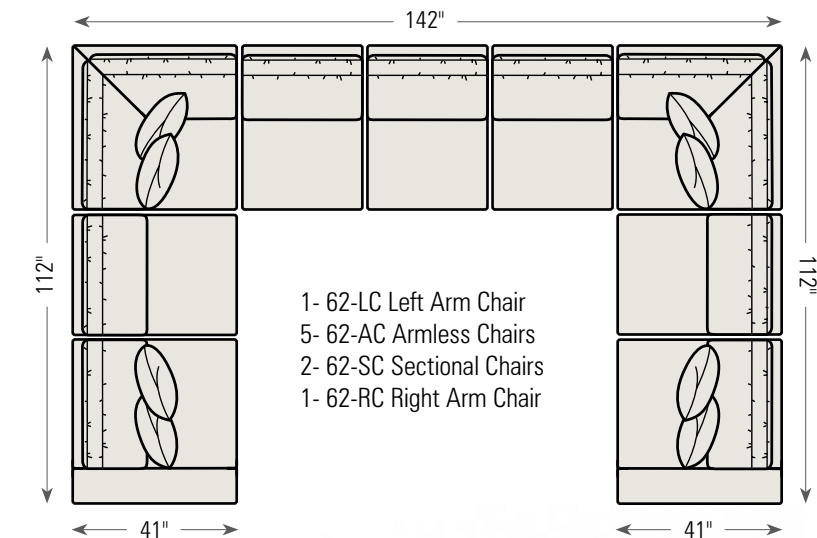

1- 62-LC Left Arm Chair  
5- 62-AC Armless Chairs  
2- 62-SC Sectional Chairs  
1- 62-RC Right Arm Chair





SB

# Design Classics

Susan Bay for  
SHERRILL FURNITURE

Award-winning designer and nationally recognized home furnishings retailer, Susan Bay



*"I design in the moment for what will survive in the future; classic, but changing traditional furniture that will have lasting value for the places and time in which we live".*

~ Susan Bay

DC366 Sofa  
SWDC299 Chair  
260-460 Moorings Credenza  
242-850 Ming Cocktail Table  
242-940 Ming Square Lamp Table







### DC104 Ottoman

52w 19d 19h  
Finish Shown: Carob Brown



### DC105 Ottoman

48w 48d 19h  
Finish Shown: Carob Brown



### DC220 Ottoman

25w 20d 19h  
Seat Height: 19  
Finish Shown: Carob Brown



### DC3 Ottoman

18w 18d 18h  
Seat Height: 18  
Finish Shown: Carob Brown



### DC106 Ottoman

21w 21d 19h  
Finish Shown: Carob Brown



### DC12 Bench

27w 21d 22h  
Standard Nail: #1-FN



### DC2 Ottoman

24w 21d 20h  
Standard Nail: #2-N  
Finish Shown: Carob Brown



### DC4 Ottoman

23w 18d 17h  
Finish Shown: Carob Brown







### DC5 Bench

25w 20d 19h



### DC221 Chair

26w 33d 33h  
Inside: 19w 19d 13h  
Arm Height: 31 Seat Height: 20  
Tight Back  
Standard Throw Pillows: One 21" x 21"  
Finish Shown: Linen



### DC225 Chair

30w 34d 37h  
Inside: 23w 22d 18h  
Arm Height: 25 Seat Height: 19  
Tight Back  
Finish Shown: Carob Brown



### DC227 Chair

28w 35d 35h  
Inside: 22w 21d 16h  
Arm Height: 20 Seat Height: 19  
Tight Back  
Standard With Dressmaker Skirt



DC221 Chair  
225-460 Marco Credenza Room





### DC228 Chair

32w 35d 37h  
 Inside: 22w 20d 18h  
 Arm Height: 24 Seat Height: 19  
 Tight Back  
 Finish Shown: Carob Brown



### DC229 Chair

29w 35d 33h  
 Inside: 22w 19d 14h  
 Arm Height: 24 Seat Height: 19  
 Loose Pillow Back  
 Finish Shown: Carob Brown



### DC277 Chair

30w 34d 40h  
 Inside: 20w 23d 20h  
 Arm Height: 27 Seat Height: 20  
 Tight Back  
 Standard Nail: #2-P  
 Finish Shown: Carob Brown



### DC370 Chair

34w 40d 37h  
 Inside: 24w 21d 17h  
 Arm Height: 25 Seat Height: 20  
 Loose Pillow Back  
 Finish Shown: Carob Brown



### DC24 Chair

31w 38d 50h  
 Inside: 27w 24d 32h  
 Arm Height: 23 Seat Height: 18  
 Tight Back  
 Finish Shown: Carob Brown



### DC26 Chair

34w 38d 35h  
 Inside: 27w 20d 16h  
 Arm Height: 22 Seat Height: 19  
 Loose Pillow Back  
 Standard Nail: # 2-FN  
 Nails Shown: # 2-PN  
 Finish Shown: Carob Brown



DC227 Chair





### SWDC201 Swivel Chair

35w 38d 36h  
 Inside: 24w 22d 17h  
 Arm Height: 24 Seat Height: 19  
 Loose Pillow Back  
 Standard With Swivel Base



### SWDC226 Swivel Chair

34w 38d 35h  
 Inside: 27w 20d 16h  
 Arm Height: 22 Seat Height: 19  
 Loose Pillow Back  
 Standard With Dressmaker Skirt  
 Standard With Swivel Base



### SWDC361 Swivel Chair

34w 36d 35h  
 Inside: 24w 21d 16h  
 Arm Height: 24 Seat Height: 19  
 Loose Pillow Back  
 Standard With Swivel Base



### SWDC992 Swivel Chair

29w 34d 31h  
 Inside: 22w 19d 13h  
 Arm Height: 24 Seat Height: 18  
 Loose Pillow Back  
 Standard With Swivel Base



### SWDC27 Swivel Chair

33w 36d 35h  
 Inside: 23w 19d 17h  
 Arm Height: 23 Seat Height: 18  
 Loose Pillow Back  
 Standard With Swivel Base



### SWDC299 Swivel Chair

29w 34d 31h  
 Inside: 22w 19d 7h  
 Arm Height: 24 Seat Height: 24  
 Loose Pillow Back  
 Standard With Dressmaker Skirt  
 Standard With Swivel Base



SWDC992 Swivel Chair





### DC19 Dining Chair

21w 26d 39h  
 Inside: 21w 19d 20h  
 Seat Height: 19  
 Tight Back  
 Standard Nail: #1-BB  
 Finish Shown: Guild



### DC62 Chair

21w 26d 37h  
 Inside: 21w 19d 18h  
 Seat Height: 19  
 Tight Back  
 Standard Without Nails  
 Shown With Optional #0-FN  
 Spaced Around Base  
 Finish Shown: Carob Brown



### DC65 Dining Chair

21w 27d 40h  
 Inside: 21w 18d 22h  
 Seat Height: 18  
 Tight Back  
 Standard Nail: #1-BB  
 Finish Shown: Bone



### DC475 Dining Chair

22w 25d 37h  
 Inside: 22w 19d 18h  
 Seat Height: 19  
 Tight Back  
 Standard Nail: #1-P  
 Finish Shown: Black



DC65 Dining Chair





965-887 End Table  
 DC131 Left Arm Corner Sofa  
 DC132 Right Arm Corner Sofa



### DC131 Left Arm Corner Sofa

104w 37D 35H  
 Inside: 80w 23D 16H  
 Arm Height: 31 Seat Height: 19  
 Tight Tufted Back  
 Standard Throw Pillows: Two 21" x 21"  
 Finish Shown: Carob Brown



### DC134 Right Arm Sofa

97w 37D 35H  
 Inside: 86w 23D 16H  
 Arm Height: 31 Seat Height: 19  
 Tight Tufted Back  
 Standard Throw Pillows: One 21" x 21"  
 Finish Shown: Carob Brown



\*Standard Nail: #1-P

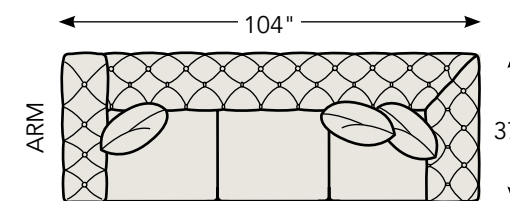
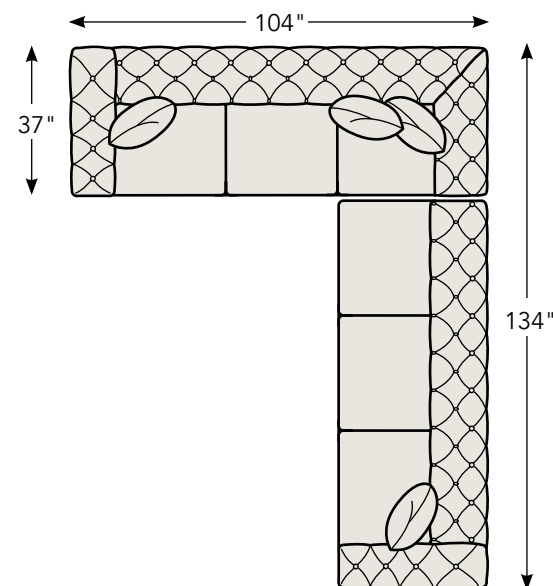

DC131 Left Arm Corner Sofa

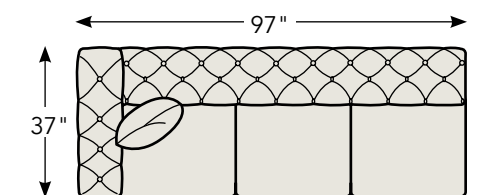

DC133 Left Arm Sofa

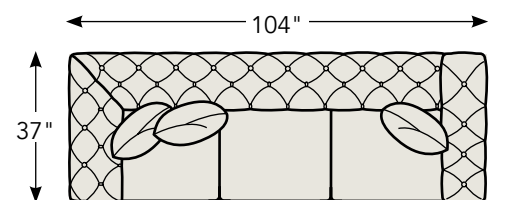

DC132 Right Arm Corner Sofa

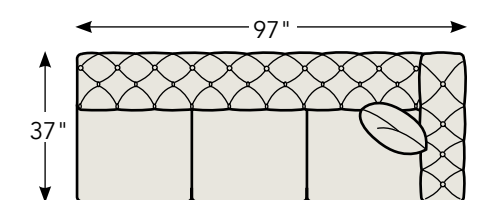

DC134 Right Arm Sofa



DC4 Ottoman  
236-770 Coco Console  
DC710 Corner Chair  
DC711 Left Arm Sofa  
DC714 Right Arm Loveseat  
225-930 Diamond Round Lamp Table  
243-850 Bay Harbor Cocktail Table



Design Classics





**DC379 Left Arm Corner Sofa**

98w 38D 37H  
 Inside: 75w 21D 20H  
 Seat Height: 20 Arm Height: 25  
 Loose Pillow Back  
 Standard With Two 21" Throw Pillows



Also Available:

**DC377 Left Arm Sofa**

83w 38D 37H

**DC378 Right Arm Corner Sofa**

98w 38D 37H

**DC380 Corner Chair**

38w 38D 37H

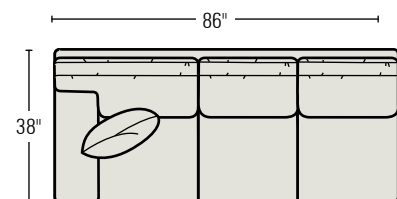

DC377 Left Arm Sofa

**DC376 Right Arm Sofa**

86w 38D 37H  
 Inside: 80w 21D 20H  
 Seat Height: 20 Arm Height: 25  
 Loose Pillow Back  
 Standard With One 21" Throw Pillows

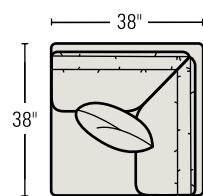

DC380 Corner Chair

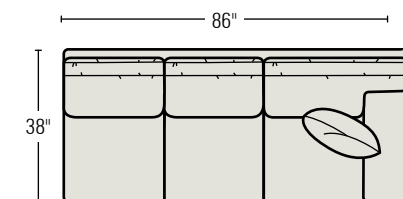

DC376 Right Arm Sofa

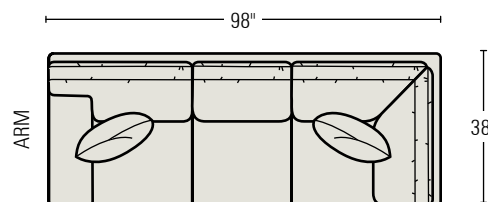

DC379 Left Arm Corner Sofa

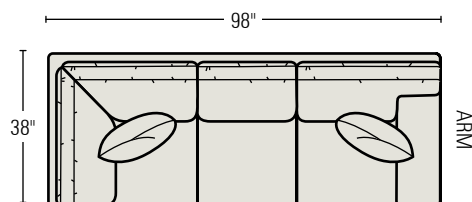

DC378 Right Arm Corner Sofa



**DC710 Corner Chair**

38w 38D 36H  
 Inside: 20w 20D 20H  
 Seat Height: 20 Arm Height: 24  
 Loose Pillow Back  
 Standard With One 21" Throw Pillow



Also Available:

**DC712 Right Arm Sofa**

82w 38D 36H

**DC713 Left Arm Loveseat**

70w 38D 36H

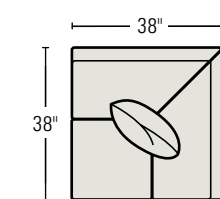

DC710 Corner Chair

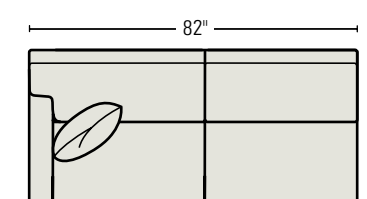

DC711 Left Arm Sofa

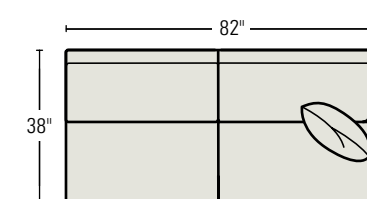

DC712 Right Arm Sofa

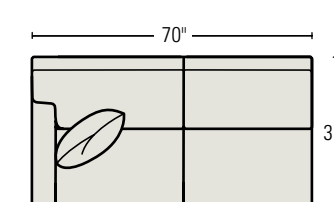

DC713 Left Arm Loveseat

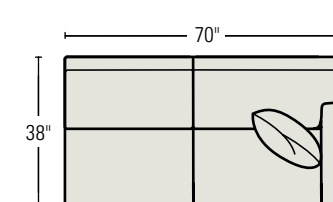

DC714 Right Arm Loveseat

**DC711 Left Arm Sofa**

82w 38D 36H  
 Inside: 76w 20D 20H  
 Seat Height: 20 Arm Height: 24  
 Loose Pillow Back  
 Standard With Two 21" Throw Pillow



Also Available:

**DC714 Right Arm Loveseat**

70w 38D 36H  
 Inside: 64w 20D 20H  
 Seat Height: 20 Arm Height: 24  
 Loose Pillow Back  
 Standard With One 21" Throw Pillow



Also Available:



### DC293 Sofa

73w 43D 35H  
 Inside: 61w 22D 16H  
 Arm Height: 24 Seat Height: 19  
 Crescent Front  
 Tight Back  
 Standard Nail: #1-FN  
 Standard Throw Pillows:  
 Two 19" x 22"  
 Standard With Brass Ferrules  
 Finish Shown: Carob Brown



### DC326 Sofa

86w 38D 37H  
 Inside: 76w 20D 18H  
 Arm Height: 22 Seat Height: 19  
 Loose Pillow Back  
 Standard Throw Pillows: Two 21" x 21"  
 Standard with Recessed Wood Legs



### DC362 Sofa

86w 38D 37H  
 Inside: 73w 21D 17H  
 Arm Height: 25 Seat Height: 20  
 Loose Pillow Back  
 Standard Throw Pillows: Two 21" x 21"  
 Finish Shown: Carob Brown



### DC366 Sofa

93w 38D 38H  
 Inside: 73w 24D 19H  
 Arm Height: 30 Seat Height: 19  
 Loose Pillow Back  
 Standard Throw Pillows: Two 21" x 21"  
 Standard With Plinth Base  
 Finish Shown: Carob Brown



### DC371 Sofa

88w 38D 36H  
 Inside: 75w 21D 16H  
 Arm Height: 24 Seat Height: 30  
 Loose Pillow Back  
 Standard Throw Pillows: Two 21" x 21"  
 Shown With Optional #3-P Nails  
 Spaced Around Base  
 No Nails Standard  
 Finish Shown: Carob Brown



### DC372 Sofa

71w 39D 36H  
 Inside: 63w 22D 18H  
 Arm Height: 22 Seat Height: 18  
 Loose Pillow Back  
 Standard Throw Pillows: Two 21" x 21"  
 Finish Shown: Carob Brown





### DC373 Sofa

87w 40D 37H  
 Inside: 78w 21D 17H  
 Arm Height: 25 Seat Height: 20  
 Loose Pillow Back  
 Standard Throw Pillows: Two 21" x 21"  
 Finish Shown: Carob Brown



### DC374 Sofa

94w 38D 37H  
 Inside: 80w 21D 18H  
 Arm Height: 25 Seat Height: 19  
 Loose Pillow Back  
 Standard Throw Pillows: Two 21" x 21"  
 Finish Shown: Carob Brown



### DC375 Sofa

80w 38D 37H  
 Inside: 68w 21D  
 Loose Pillow Back  
 Arm Height: 25 Seat Height: 19  
 Standard Throw Pillows: Two 21" x 21"  
 Finish Shown: Carob Brown



### DC50 Sofa

74w 37D 35H  
 Inside: 55w 23D 15H  
 Arm Height: 30 Seat Height: 20  
 Tight Tufted Back  
 Standard Throw Pillows: Two 21" x 21"  
 Standard Nail: #1-BZ  
 Finish Shown: Carbon Brown



### DC71 Sofa

82w 38D 36H  
 Inside: 69w 21D 16H  
 Arm Height: 24 Seat Height: 20  
 Loose Pillow Back  
 Standard Throw Pillows: Two 21" x 21"  
 No Nails Standard  
 Shown With Optional #3-V  
 Nails Spaced  
 Over Taped Around Base  
 Finish Shown: Brown Mahogany



### DC89 Sofa

101w 37D 35H  
 Inside: 82w 23D 16H  
 Arm Height: 30 Seat Height: 19  
 Tight Tufted Back  
 Standard Throw Pillows: Two 21" x 21"  
 Standard Nail: #1-BZ  
 Finish Shown: Carob Brown







SWDC992 Swivel Chair  
260-460 Moorings Credenza  
969-486 Castel Hex Accent Table



# Chairs & Ottomans

Every Sherrill chair and ottoman is designed and crafted to last generations. Our North Carolina skilled craftspeople take pride in creating each piece with pride knowing that it will be cherished for years.

## THE SHERRILL WAY:

Frame Construction



*Sherrill blends traditional hand-craftsmanship with modern manufacturing methods to produce frames that are among the finest and strongest available. Each frame is precisely cut and hand assembled with time proven methods and techniques.*





**W10 Chair**

31w 35d 36h  
 Inside: 26w 22d 17h  
 Arm Height: 25 Seat Height: 19  
 Tight Back  
 Finish Shown: Carob Brown



**1015-1 Chair**

29w 28d 30h  
 Inside: 21d 13h  
 Seat Height: 17  
 Tight Back  
 Finish Shown: Carob Brown



**1284-1 Chair**

28w 36d 37h  
 Inside: 19w 22d 18h  
 Arm Height: 24 Seat Height: 19  
 Tight Back  
 Standard With Recessed Wood Foot



**1306-1 Chair**

28w 29d 35h  
 Inside: 20w 18d 17h  
 Arm Height: 24 Seat Height: 18  
 Loose Pillow Back  
 Standard With Skirt



**F118-01 Chair**

28w 27d 32h  
 Inside: 18w 19d 16h  
 Arm Height: 30 Seat Height: 17  
 Tight Back  
 Standard Nail: #1-FN Head To Head Around Base  
 Finish Shown: Carob Brown



**F1262-01 Chair**

27w 32d 38h  
 Inside: 19w 19d 20h  
 Arm Height: 28 Seat Height: 18  
 Tight Tufted Back  
 Standard Nail: #1-FN  
 Finish Shown: Carob Brown



F1262-01 Chair





### 1315 Chair

28w 31d 33h  
 Inside: 21w 22d 14h  
 Arm Height: 25 Seat Height: 19  
 Tight Tufted Back  
 Finish Shown: Carob Brown



### 1313 Chair

30w 37d 36h  
 Inside: 22w 21d 16h  
 Arm Height: 25 Seat Height: 20  
 Loose Pillow Back  
 Finish Shown: Carob Brown  
 Shown With Optional #1-FN Nails  
 Around Base  
 Standard Without Nails



### 1329 Chair

37w 40d 38h  
 Inside: 27w 23d 20h  
 Arm Height: 26 Seat Height: 28  
 Loose Pillow Back  
 Standard With Dressmaker Skirt



### 1338 Chair

36w 38d 38h  
 Inside: 23w 23d 19h  
 Arm Height: 24 Seat Height: 19  
 Loose Pillow Back  
 Finish Shown: Carob Brown



### 1339 Ottoman

27w 21d 18h



1315 Chair



### 1319 Chair

33w 35d 33h  
 Inside: 22w 21d 15h  
 Arm Height: 23 Seat Height: 18  
 Loose Pillow Back  
 Standard Nail: #1-P  
 Nail Shown: #1-FN  
 Finish Shown: Carob Brown



### 1346 Chair

30w 37d 39h  
 Inside: 23w 20d 20h  
 Arm Height: 25 Seat Height: 19  
 Loose Pillow Back  
 Finish Shown: Carob Brown



### 1347 Ottoman

26w 20d 17h



### 1424 Chair

28w 31d 42h  
 Inside: 20w 22d 25h  
 Arm Height: 18 Seat Height: 17  
 Loose Pillow Back  
 Standard Nail: #1-V  
 Finish Shown: Carob Brown







### 1427 Chair

31w 34d 38H  
 Inside: 23w 21d 19H  
 Arm Height: 25 Seat Height: 19  
 Loose Pillow Back  
 Standard Nail: #1-FN  
 Standard With Dressmaker Skirt



### 1435 Chair

35w 39d 43H  
 Inside: 19d 24H  
 Arm Height: 25 Seat Height: 19  
 Loose Pillow Back  
 Standard With Dressmaker Skirt



### 1440-1 Chair

32w 38d 35H  
 Inside: 24w 22d 16H  
 Arm Height: 24 Seat Height: 19  
 Loose Pillow Back  
 Standard Without Nails  
 Nail Shown: #1-FN  
 Finish Shown: Carob Brown



### 1449-1 Chair

36w 35d 36H  
 Inside: 21d 18H  
 Arm Height: 24 Seat Height: 18  
 Loose Pillow Back  
 Standard With Kick Pleat Skirt







### 1450 Chair

33w 37D 40H  
 Inside: 21w 21D 20H  
 Arm Height: 25 Seat Height: 20  
 Loose Pillow Back  
 Standard Without Nails  
 Shown With Optional #2-FN Spaced Nails  
 Standard With Recessed Wood Leg  
 Shown With Optional Swivel Base



### 1451 Lounge Chair

33w 37D 40H  
 Inside: 21w 21D 20H  
 Arm Height: 25 Seat Height: 20  
 Loose Pillow Back  
 Standard With Recessed Wood Legs  
 Shown With Optional Swivel Base



### 1524-1 Chair

30w 34D 38H  
 Inside: 21w 21D 20H  
 Arm Height: 23 Seat Height: 18  
 Semi-Attached Back  
 Standard With Kick Pleat Skirt



### 1529-1 Chair

37w 38D 36H  
 Inside: 20w 21D 17H  
 Arm Height: 23 Seat Height: 19  
 Loose Pillow Back  
 Standard With Kick Pleat Skirt  
 Finish Shown: Brown Mahogany



### 1575-O Ottoman

26w 22D 15H  
 Standard With Roller



### 1452 Chair

33w 37D 40H  
 Inside: 21w 21D 20H  
 Arm Height: 25 Seat Height: 20  
 Loose Pillow Back  
 Standard With Recessed Wood Leg  
 Shown With Optional Swivel Base



### 1507-1 Chair

33w 39D 38H  
 Inside: 22D 20H  
 Arm Height: 25 Seat Height: 18  
 Semi-Attached Back  
 Standard With Kick Pleat Skirt



### 1534-1 Chair

30w 36D 37H  
 Inside: 23w 21D 18H  
 Arm Height: 25 Seat Height: 19  
 Loose Pillow Back  
 Finish Shown: Brown Mahogany



### 1536-1 Chair

33w 37D 36H  
 Inside: 21w 21D 17H  
 Arm Height: 24 Seat Height: 19  
 Semi-Attached Back  
 Standard With Kick Pleat Skirt







### 1542-1 Chair

29w 36d 38h  
 Inside: 20w 22d 20h  
 Arm Height: 23 Seat Height: 18  
 Standard Nail: #1-FN  
 Finish Shown: Carob Brown



### 1544-1 Chair

34w 36d 39h  
 Inside: 20w 20d 21h  
 Arm Height: 23 Seat Height: 18  
 Loose Pillow Back  
 Standard With Kick Pleat Skirt



### F1558-01 Chair

36w 35d 38h  
 Inside: 21w 20d 19h  
 Arm Height: 25 Seat Height: 19  
 Semi-Attached Back  
 Finish Shown: Carob Brown



### F1568-01 Chair

36w 35d 38h  
 Inside: 21w 20d 18h  
 Arm Height: 26 Seat Height: 20  
 Semi-Attached Back  
 Finish Shown: Carob Brown



### 1555-1 Chair

29w 32d 36h  
 Inside: 22w 20d 17h  
 Arm Height: 24 Seat Height: 19  
 Tight Back  
 Finish Shown: Carob Brown



### 1557-1 Chair

29w 36d 37h  
 Inside: 22w 22d 19h  
 Arm Height: 24 Seat Height: 18  
 Semi-Attached Back  
 Standard Nail: #1-FN  
 Finish Shown: Carob Brown



### 1578-1 Chair

30w 36d 36h  
 Inside: 21d 17h  
 Arm Height: 24 Seat Height: 19  
 Loose Pillow Back  
 Standard With Dressmaker Skirt



### 1580-1 Chair

29w 31d 31h  
 Inside: 22w 23d 13h  
 Arm Height: 27 Seat Height: 18  
 Tight Back  
 Finish Shown: Carob Brown







**1581-1 Chair**

32w 33d 38h  
 Inside: 22d 19h  
 Arm Height: 25 Seat Height: 19  
 Tight Button Back  
 Finish Shown: Carob Brown



**1586-1 Chair**

29w 35d 39h  
 Inside: 23d 20h  
 Arm Height: 25 Seat Height: 19  
 Tight Tufted Back  
 Finish Shown: Carob Brown



**1632 Chair**

25w 30d 36h  
 Inside: 20w 21d 18h  
 Arm Height: 29 Seat Height: 18  
 Tight Back  
 Standard Nail: #1-FN  
 Finish Shown: Carob Brown



**1633 Chair**

28w 32d 36h  
 Inside: 20w 22d 18h  
 Arm Height: 28 Seat Height: 18  
 Tight Back  
 Standard Nail: #1-FN  
 Finish Shown: Carob Brown



**1596-1 Chair**

30w 36d 36h  
 Inside: 24w 21d 17h  
 Arm Height: 24 Seat Height: 19  
 Loose Pillow Back  
 Finish Shown: Carob Brown



**1634 Chair**

25w 30d 30h  
 Inside: 22d 12h  
 Arm Height: 27 Seat Height: 18  
 Tight Back  
 Standard With Dressmaker Skirt



1632 Chair





### 1635 Chair

31w 33D 31H  
 Inside: 19w 24D 13H  
 Arm Height: 27 Seat Height: 18  
 Tight Back  
 Standard Nail: #1-FN  
 Finish Shown: Carob Brown



### F1660-01 Chair

32w 35D 36H  
 Inside: 21w 21D 17H  
 Arm Height: 23 Seat Height: 19  
 Loose Pillow Back  
 Standard Throw Pillows: One 21" x 21"  
 Available In Natural On Walnut Only



### 1720 Chair

31w 38D 39H  
 Inside: 24w 21D 20H  
 Arm Height: 24 Seat Height: 19  
 Loose Pillow Back  
 Finish Shown: Carob Brown



### 1722-1 Chair

33w 37D 37H  
 Inside: 23w 21D 18H  
 Arm Height: 23 Seat Height: 19  
 Loose Pillow Back  
 Standard With Kick Pleat Skirt



### 1718 Chair

32w 38D 37H  
 Inside: 22w 22D 18H  
 Arm Height: 26 Seat Height: 19  
 Loose Pillow Back  
 Standard Nail: #1-BZ  
 Finish Shown: Carob Brown



### 1719 Chair

33w 38D 33H  
 Inside: 24w 21D 14H  
 Arm Height: 25 Seat Height: 19  
 Loose Pillow Back  
 Standard With Dressmaker Skirt



### 1730 Chair

41w 41D 40H  
 Inside: 21w 22D 22H  
 Arm Height: 26 Seat Height: 18  
 Tight Tufted Back  
 Standard With Brass Ferrules  
 Standard With Brass Casters  
 Finish Shown: Carob Brown



### 1731 Ottoman

29w 22D 17H



### 1735 Chair

34w 39D 40H  
 Inside: 24w 21D 21H  
 Arm Height: 24 Seat Height: 19  
 Semi-Attached Back  
 Standard Nail: #1-FN & #3-FN  
 Nail Shown: #1-V & #3-V  
 Finish Shown: Carob Brown



### 1735-O Ottoman

29w 22D 18H





**1735-N Chair**

34w 39d 40h  
 Inside: 24w 21d 21h  
 Arm Height: 24 Seat Height: 19  
 Semi-Attached Back  
 Finish Shown: Carob Brown



Also Available:

**1735-O-N Ottoman**

29w 22d 18h



**1755 Chair**

35w 39d 37h  
 Inside: 26w 21d 18h  
 Arm Height: 25 Seat Height: 19  
 Loose Pillow Back  
 Finish Shown: Carob Brown



**1755-O Ottoman**

31w 22d 17h



**1750-1 Chair**

29w 38d 37h  
 Inside: 20w 22d 18h  
 Arm Height: 24 Seat Height: 19  
 Semi-Attached Back  
 Standard Nail: #1-FN  
 Standard With Recessed Wood Leg



**1755-D Chair**

35w 39d 37h  
 Inside: 26w 21d 18h  
 Arm Height: 25 Seat Height: 19  
 Loose Pillow Back  
 Standard With Dressmaker Skirt



**1755-O-D Ottoman**

31w 22d 17h  
 Standard With Rollers  
 Standard With Dressmakers Skirt

1750-1 Chair  
 223-960 Corbel Side Table







### 1757-1 Chair

34w 36D 39H  
 Inside: 21w 20D 20H  
 Arm Height: 23 Seat Height: 19  
 Loose Pillow Back  
 Standard With Recessed Wood Leg  
 Shown With Optional Swivel Base



### 1759-1 Chair

33w 37D 37H  
 Inside: 23w 21D 18H  
 Arm Height: 23 Seat Height: 19  
 Loose Pillow Back  
 Standard With Recessed Wood Leg  
 Shown With Optional Swivel Base



### 1785 Chair

31w 37D 40H  
 Inside: 23w 20D 21H  
 Arm Height: 24 Seat Height: 19  
 One Semi-Attached Back  
 Finish Shown: Carob Brown



### 1789 Chair

41w 44D 41H  
 Inside: 31w 23D 21H  
 Arm Height: 27 Seat Height: 20  
 Loose Pillow Back  
 Standard Throw Pillow: One 14" x 27" Kidney Pillow  
 Standard Nail: #4-N Spaced  
 Finish Shown: Carob Brown



### 1790 Ottoman

34w 25D 18H  
 Standard Nail: #4-N Spaced  
 Standard With Rollers



### 1763 Chair

31w 34D 38H  
 Inside: 22w 19D 19H  
 Arm Height: 26 Seat Height: 19  
 Loose Pillow Back  
 Standard With Dressmaker Skirt



### 1768 Chair

31w 40D 37H  
 Inside: 19w 22D 18H  
 Arm Height: 27 Seat Height: 19  
 Semi-Attached Back  
 Standard Nail: #1-FN  
 Standard With Brass Ferrules  
 Standard With Brass Casters  
 Finish Shown: Carob Brown



### 1769 Ottoman

27w 20D 18H



### 1796 Chair

33w 35D 43H  
 Inside: 23w 21D 23H  
 Arm Height: 20 Seat Height: 20  
 Semi-Attached Back  
 Standard Nail: #1-P  
 Finish Shown: Hemp



### 1819 Chair

33w 39D 36H  
 Inside: 24w 21D 17H  
 Arm Height: 24 Seat Height: 19  
 Loose Pillow Back  
 Standard With Recessed Wood Leg  
 Shown With Optional Swivel Base







### 1852 Chair

34w 39D 40H  
 Inside: 22w 19D 21H  
 Arm Height: 25 Seat Height: 19  
 Semi-Attached Back  
 Standard With Dressmaker Skirt



### 1855 Chair

35w 39D 37H  
 Inside: 26w 21D 18H  
 Arm Height: 25 Seat Height: 19  
 Loose Pillow Back  
 Standard With Recessed Wood Leg



Also Available

### 1855-0 Ottoman

35w 22D 17H  
 Standard With Rollers



### 1878 Chair

31w 40D 37H  
 Inside: 19w 22D 18H  
 Arm Height: 27 Seat Height: 19  
 One Semi-Attached Back  
 Standard Nail: #1-FN  
 Finish Shown: Carob Brown



### 1879 Ottoman

27w 20D 18H



### 1947 Chair

32w 38D 38H  
 Inside: 23w 23D 18H  
 Arm Height: 25 Seat Height: 20  
 Loose Pillow Back  
 Finish Shown: Carob Brown



### 2266 Right Arm Chaise

70w 32D 41H  
 Inside: 58w 58D 19H  
 Arm Height: 36 Seat Height: 22  
 Tight Back  
 Standard Throw Pillows:  
 One 22" x 20"  
 One Cylinder 8" x 25"  
 Finish Shown: Brown Mahogany



### 2267 Left Arm Chaise

70w 32D 41H  
 Inside: 58w 58D 19H  
 Arm Height: 36 Seat Height: 22  
 Tight Back  
 Standard Throw Pillows:  
 One 22" x 20"  
 One Cylinder 8" x 25"  
 Finish Shown: Brown Mahogany



1852 Chair  
 965-888 Spot Table  
 225-990 Marco Two Door Cabinet





### 2364 Chair

38w 41D 38H  
 Inside: 22w 23D 19H  
 Arm Height: 28 Seat Height: 19  
 Loose Pillow Back  
 Standard Nail: #1-BZ, #3-BZ Spaced  
 Finish Shown: Carob Brown



Also Available:

### 2365 Ottoman

28w 21D 17H



### 3340 Chair

32w 36D 36H  
 Inside: 21w 20D 18H  
 Arm Height: 22 Seat Height: 18  
 Loose Pillow Back  
 Standard With Dressmaker Skirt



### 3331 Chair

28w 37D 37H  
 Inside: 21w 20D 19H  
 Arm Height: 25 Seat Height: 18  
 Loose Pillow Back  
 Standard With Dressmaker Skirt



### 3341 Chair

28w 37D 37H  
 Inside: 21w 20D 19H  
 Arm Height: 25 Seat Height: 18  
 Loose Pillow Back  
 Standard With Recessed Wood Legs  
 Shown With Optional Swivel Base



4333-4 Sofa  
 F420-01 Chair  
 967-165 Olivia Spot Table

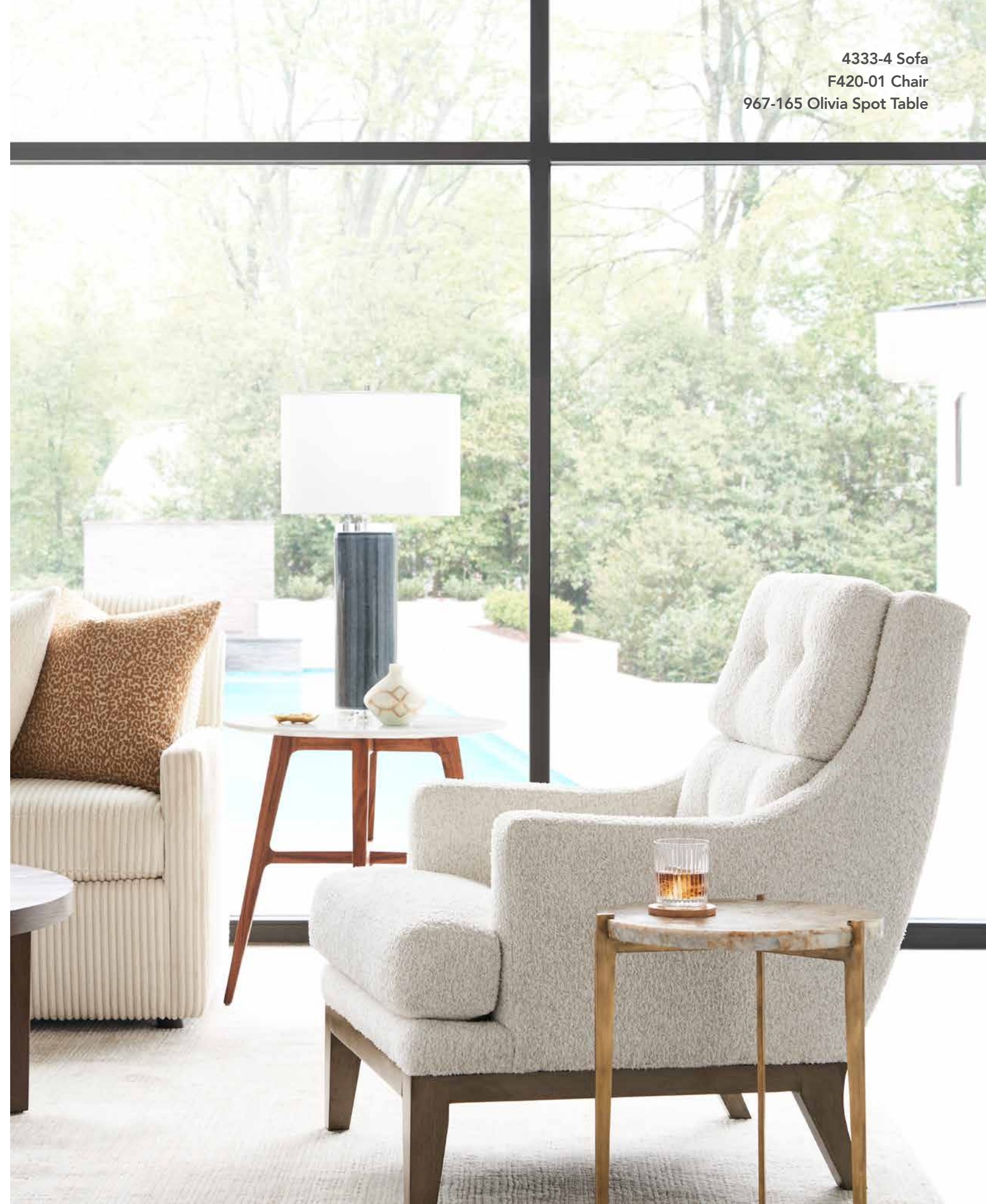





### 3367L Chair

36w 39d 39h  
 Inside: 21w 22d 19h  
 Arm Height: 26 Seat Height: 20  
 Loose Pillow Back  
 Standard With Kick Pleat Skirt



### 3968 Chair

31w 40d 37h  
 Inside: 20w 22d 18h  
 Arm Height: 27 Seat Height: 19  
 One Semi-Attached Back  
 Standard Nail: #1-FN  
 Standard With Brass Ferrules  
 Finish Shown: Antique Walnut



### 3969 Ottoman

27w 20d 18h



### F438-01 Chair

32w 42d 39h  
 Inside: 23w 24d 19h  
 Arm Height: 24 Seat Height: 20  
 Loose Pillow Back  
 Standard Nail: #2-N  
 Standard With Brass Ferrules  
 Finish Shown: Carob Brown



### 1855-00 Ottoman

26w 21d 17h  
 Standard Nail: #2-N  
 Standard With Rollers



### 5501-T Chair

32w 33d 36h  
 Inside: 22w 22d 21h  
 Arm Height: 28 Seat Height: 19  
 Loose Pillow Back



### 5500 Ottoman

21w 21d 18h  
 Standard With Rollers



### F371-01 Chair

31w 33d 36h  
 Inside: 23w 19d 19h  
 Arm Height: 22 Seat Height: 17  
 Tight Back  
 Available In Natural On Walnut Only



### F420-01 Chair

30w 38d 40h  
 Inside: 22w 24d 22h  
 Arm Height: 25 Seat Height: 18  
 Split Semi-Attached Back  
 Split Seat Cushion  
 Finish Shown: Carob Brown



F420-01 Chair





# Swivel Chairs

Perfect in pairs, Sherrill swivel chairs encourage conversation and enable functionality for any room. For even more options, see our selection of swivel rocker and motion swivel chairs.



## Swivel Option

A swivel base adds extra functionality to any room in your home allowing more sitting, viewing and interaction opportunities.



## Swivel Rocker

Select seating styles offer optional glider/ rocker motion with full 360° smooth swivel turning ability.

### THE SHERRILL WAY:

Motion Mechanisms



*For our swivel, swivel rocker and motion swivel chairs, Sherrill uses the industry's top mechanisms ensuring the most comfort and ease of use.*







**SW1321 Swivel Chair**

32w 30d 29h  
 Inside: 21w 22d 11h  
 Arm Height: 29 Seat Height: 18  
 Tight Back  
 Finish Shown: Carob Brown



**SWR1330 Swivel Rocker**

35w 37d 39h  
 Inside: 21d 19h  
 Arm Height: 26 Seat Height: 20  
 Semi-Attached Back  
 Standard With Kick Pleat Skirt



**SW1425 Swivel Chair**

31w 31d 31h  
 Inside: 24d 12h  
 Arm Height: 26 Seat Height: 19  
 Tight Back



**SWR1527-1 Swivel Rocker**

36w 38d 36h  
 Inside: 21w 19d 17h  
 Arm Height: 24 Seat Height: 19  
 Semi-Attached Back  
 Standard With Kick Pleat Skirt



**SW1409 Swivel Chair**

35w 34d 30h  
 Inside: 23w 22d 11h  
 Arm Height: 25 Seat Height: 19  
 Tight Back



**SW1409-P Swivel Chair**

35w 34d 30h  
 Inside: 23w 22d 11h  
 Arm Height: 25 Seat Height: 19  
 Tight Back



**SW1619 Swivel Chair**

33w 36d 34h  
 Inside: 24w 20d 15h  
 Arm Height: 20 Seat Height: 19  
 Loose Pillow Back



**SW1714 Swivel Chair**

34w 39d 38h  
 Inside: 21w 22d 19h  
 Arm Height: 24 Seat Height: 19  
 Loose Pillow Back  
 Standard With Kick Pleat Skirt







**SW1715 Swivel Chair**

35w 37D 39H  
 Inside: 19w 21D 19H  
 Arm Height: 26 Seat Height: 20  
 Loose Pillow Back



**SWR1744 Swivel Rocker**

34w 39D 38H  
 Inside: 23w 22D 19H  
 Arm Height: 24 Seat Height: 19  
 Loose Pillow Back  
 Standard With Dressmaker Skirt



**SW2342 Right Arm Swivel Chair**

33w 34D 30H  
 Inside: 27w 21D 11H  
 Arm Height: 29 Seat Height: 19  
 Loose Pillow Back



**SW2343 Left Arm Swivel Chair**

33w 34D 30H  
 Inside: 27w 21D 11H  
 Arm Height: 29 Seat Height: 19  
 Loose Pillow Back



**SW1758 Swivel Chair**

36w 39D 35H  
 Inside: 24w 21D 15H  
 Arm Height: 23 Seat Height: 20  
 Loose Pillow Back  
 Standard Nail: #2-FN  
 Shown With Optional #2P Nails



**FS256-01 Swivel Chair**

32w 38D 37H  
 Inside: 19w 23D 19H  
 Arm Height: 26 Seat Height: 18  
 Standard With Swivel Base  
 Shown With Optional #1-FN Nails  
 Around Base



FS256-01 Swivel Chair



**SW5501-T Swivel Chair**

32w 33D 36H  
 Inside: 22w 22D 21H  
 Arm Height: 28 Seat Height: 19  
 Loose Pillow Back







# Motion Swivel Chairs

Exceptional, American-made motion swivel chairs fusing traditional craftsmanship and modern methods for unparalleled custom comfort.

**Note:** MSW indicates chair is standard with motion swivel. Chairs Rotate 360° & Glide.



969-476 Tulip Table  
MSW1660 Motion Swivel Chair





**FM1994-01 Motion Swivel Chair**

28w 41D 39H  
 Inside: 20w 20D 21H  
 Arm Height: 26 Seat Height: 18  
 Semi-Attached Back



**FM419-01 Motion Swivel Chair**

36w 40D 40H  
 Inside: 21w 20D 21H  
 Arm Height: 27 Seat Height: 19  
 Semi-Attached Back  
 Standard Nail: #1-FN



**MSW1579-1 Motion Swivel Chair**

32w 37D 34H  
 Inside: 20.5w 20D 15H  
 Arm Height: 24 Seat Height: 19  
 Loose Pillow Back



**MSW1660 Motion Swivel Chair**

28w 33D 31H  
 Inside: 20w 22D 12H  
 Arm Height: 25 Seat Height: 19  
 Tight Back



**MSW1502-1 Motion Swivel Chair**

28w 34D 31H  
 Inside: 20w 22D 12H  
 Arm Height: 25 Seat Height: 19  
 Tight Back  
 Standard With Kick Pleat Skirt



**MSW1737 Motion Swivel Chair**

33w 38D 41H  
 Inside: 23w 23D 21H  
 Arm Height: 25 Seat Height: 20  
 Tight Back  
 Standard Nail: #1-FN



MSW1660 Motion Swivel Chair  
 MH25323-91 Baton Spot Table  
 MH26351 McCobb Bookcase





1660 Wing Chair  
VMA-065 Mia Accent Table



# Wing Chairs

Our wing chairs are cozy and comforting. Our selection includes wingback chairs offered in a wide variety of styles, ranging from traditional to modern wingback chairs. Specify any fabric and finish for a timeless and custom look.





### 1351 Chair

33w 36D 43H  
 Inside: 24w 23D 23H  
 Arm Height: 20 Seat Height: 20  
 Tight Back  
 Standard Nail: #1-FN  
 Finish Shown: Granite



### 1363 Chair

29w 36D 42H  
 Inside: 22w 22D 23H  
 Arm Height: 26 Seat Height: 19  
 Tight Back  
 Standard Nail: #1-FN  
 Finish Shown: Brown Mahogany



### 1660 Chair

30w 38D 50H  
 Inside: 22w 19D 31H  
 Arm Height: 25 Seat Height: 19  
 Tight Back  
 Standard Throw Pillows: 1 Kidney  
 Standard With Brass Ferrules  
 Finish Shown: Carob Brown



### F1670-01 Chair

39w 32D 48H  
 Inside: 21w 30D 22H  
 Arm Height: 26 Seat Height: 20  
 Standard Nail: #1-FN  
 Standard Finish: Brown Mahogany



### 1600 Chair

31w 36D 44H  
 Inside: 23w 23D 23H  
 Arm Height: 26 Seat Height: 21  
 Tight Back  
 Standard Nails: #1-FN  
 Shown Without Standard Nails #1-FN  
 Around Base, Outside Arm And Wings  
 Finish Shown: Carob Brown



### 1638 Chair

30w 35D 45H  
 Inside: 23w 23D 25H  
 Arm Height: 23 Seat Height: 20  
 Tight Tufted Back  
 Finish Shown: Carob Brown  
 Standard Nail: #1-FN



### F1688-01 Chair

29w 39D 40H  
 Inside: 21w 22D 22H  
 Arm Height: 22 Seat Height: 19  
 Shown With Optional #1-P Nail Trim  
 Standard Nail: #1FN  
 Finish Shown: Hemp



### 1783 Chair

33w 36D 40H  
 Inside: 21w 20D 21H  
 Arm Height: 24 Seat Height: 19  
 Standard Nail: #1-FN  
 Finish Shown: Carob Brown







**3317 Chair**

30w 38D 39H  
 Inside: 20w 21D 20H  
 Arm Height: 24 Seat Height: 19  
 Loose Pillow Back  
 Finish Shown: Carob Brown



**3318 Ottoman**

26w 20D 18H



**1455-1 Chair**

31w 34D 45H  
 Inside: 20D 25H  
 Arm Height: 26 Seat Height: 20  
 Tight Back  
 Finish Shown: Carob Brown  
 Standard Nail: #1-FN



**1551-1 Chair**

29w 34D 44H  
 Inside: 20D 23H  
 Arm Height: 26 Seat Height: 21  
 Tight Back  
 Finish Shown: Carob Brown



**1704-1 Chair**

30w 37D 38H  
 Inside: 18w 22D 18H  
 Arm Height: 24 Seat Height: 20  
 Tight Back  
 Standard With Dressmaker Skirt



**1510-1 Chair**

32w 35D 43H  
 Inside: 21w 23D 24H  
 Arm Height: 26 Seat Height: 19  
 Tight Button Back  
 Standard Nail: #1-FN  
 Finish Shown: Carob Brown



**1517-1 Chair**

33w 34D 45H  
 Inside: 20w 21D 26H  
 Arm Height: 27 Seat Height: 19  
 Tight Back  
 Finish Shown: Carob Brown



**1505-O Bench**

24w 18D 16H



**F485-01 Chair**

34w 36D 42H  
 Inside: 21w 22D 23H  
 Arm Height: 27 Seat Height: 19  
 Tight Back  
 Standard Nail: #2-FN Spaced  
 Finish Shown: Carob Brown



1551-1 Chair





# Carved Chairs

Our exposed carved wood chairs offer yet another opportunity for customization. Select your favorite finish to create your own one-of-a-kind look. Every finish is hand-applied by Sherrill craftspeople at our workroom in the USA.



1146 Chair

Chairs Shown In Silver Fox Finish





### 1014-1 Chair

27w 27d 38h  
Inside: 22w 22d 20h  
Arm Height: 25 Seat Height: 18  
Tight Back  
Finish Shown: Stone



### 1029 Chair

30w 32d 43h  
Inside: 25w 22d 23h  
Arm Height: 27 Seat Height: 20  
Tight Back  
Finish Shown: Nutmeg



### 1108 Chair

30w 35d 38h  
Inside: 24w 20d 19h  
Arm Height: 25 Seat Height: 19  
Tight Back  
Standard With One Kidney Pillow 11" x 20"  
Standard Nail: #1-FN  
Finish Shown: Carob Brown



### 1119 Chair

33w 35d 39h  
Inside: 26w 20d 20h  
Arm Height: 23 Seat Height: 19  
Loose Pillow Back  
Standard Throw Pillows: One Kidney 10" x 19"  
Finish Shown: Nutmeg



### 1118 Ottoman

33w 25d 18h



### 1034 Chair

28w 37d 40h  
Inside: 22w 21d 19h  
Arm Height: 25 Seat Height: 21  
Tight Back  
Finish Shown: Mink



### 1059 Chair

24w 28d 36h  
Inside: 19w 19d 17h  
Arm Height: 25 Seat Height: 19  
Tight Back  
Available In Brentwood & Shirewood Only



### 1146 Chair

28w 34d 39h  
Inside: 22w 21d 20h  
Arm Height: 25 Seat Height: 19  
Tight Back  
Finish Shown: Granite



1108 Chair





# Dining Chairs

The dining room is often referred to as the heart of the home. It is a place for family and friends to gather and connect over a shared meal. We craft our dining chairs to further encourage the conversations that take place around the table. Our styles of dining chairs range from traditional to transitional, which ensures everyone can find a look they love.

Our upholstered dining chairs provide extra comfort, making them ideal for when family dinners or parties run longer. One benefit of upholstered dining chairs is how they can add color and texture to make a statement in your dining room.



Sherrill Occasional 308-002 Chair  
DC19 Dining Chair  
DC65 Dining Chair  
6052 Dining Chair





### 6050 Dining Chair

21w 24d 41h  
 Inside: 16d 22h  
 Seat Height: 19  
 Tight Back  
 Finish Shown: Brown Mahogany



### 6052 Dining Chair

21w 27d 44h  
 Inside: 18d 23h  
 Seat Height: 21  
 Tight Tufted Back  
 Finish Shown: Brown Mahogany



### DC62 Chair

21w 26d 37h  
 Inside: 21w 19d 18h  
 Seat Height: 19  
 Finish Shown: Carob Brown  
 Shown With Optional #0-P Nails Spaced Around Base



### DC65 Dining Chair

21w 27d 40h  
 Inside: 21w 18d 22h  
 Seat Height: 18  
 Tight Back  
 Standard Nail: #1-BB  
 Finish Shown: Bone



### DC19 Dining Chair

21w 26d 39h  
 Inside: 21w 19d 20h  
 Seat Height: 19  
 Tight Back  
 Standard Nail: #1-BB  
 Finish Shown: Guild



### DC475 Dining Chair

22w 25d 37h  
 Inside: 22w 19d 18h  
 Seat Height: 19  
 Tight Back  
 Standard Nail: #1-P  
 Finish Shown: Brown Mahogany

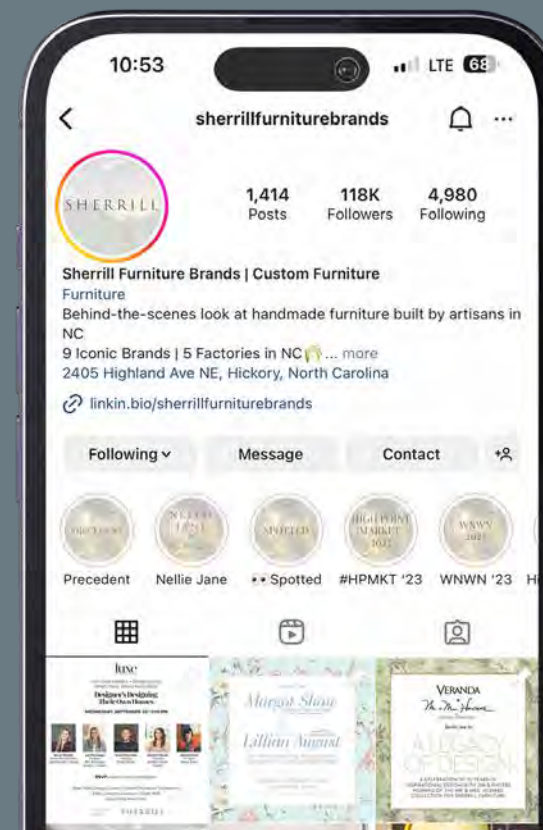

To Stay Up To Date  
 On All Things  
 Sherrill Furniture,  
 Follow Us On  
 Instagram!

@SherrillFurnitureBrands







# Ottomans & Benches

Perfect for extra seating and added style. Mitered, tufted, skirted, or fringed, Sherrill has the look for you. Kick back, relax, and put your feet up with an ottoman that is just as original as you are.

## THE SHERRILL WAY:

Nail Head Trim



*The perfect way to accent your Sherrill frame, nail head trim options range from Vintage to Natural to Polished Nickel. With an assortment of sizes, finishes, and spacing to choose from it's easy to create a unique look .*

1346 Chair  
DC373 Sofa  
LDC105 Ottoman







### 138-O Ottoman

43w 28d 17h  
Standard With Brass Ferrules  
Finish Shown: Brown Mahogany



### 139-O Ottoman

18w 18d 18h



### 1332 Ottoman

28w 22d 17h  
Finish Shown: Brown Mahogany



### 1339 Ottoman

27w 21d 18h  
Finish Shown: Carob Brown



### 148-O Ottoman

43w 29d 17h  
Finish Shown: Carob Brown



### 1118 Ottoman

33w 25d 18h  
Finish Shown: Brown Mahogany



### 1347 Ottoman

26w 20d 17h  
Finish Shown: Winchester



### 1378 Ottoman

27w 21d 18h  
Standard With Kick Pleat Skirt  
Standard With Rollers







**1413 Ottoman**

34w 26d 18h  
 Standard With Kick Pleat Skirt  
 Standard With Rollers



**1505-O Bench**

24w 18d 16h  
 Finish Shown: Brown Mahogany



**1570-O Ottoman**

27w 21d 17h  
 Standard With Kick Pleat Skirt  
 Standard With Rollers



**1575-O Ottoman**

26w 22d 15h  
 Standard With Kick Pleat Skirt  
 Standard With Rollers



**1523-O Ottoman**

25w 21d 15h  
 Standard With Kick Pleat Skirt  
 Standard With Rollers



**1565-O Ottoman**

25w 21d 15h  
 Finish Shown: Antique Fruitwood



**1591 Ottoman**

34w 25d 18h  
 Standard With Kick Pleat Skirt  
 Standard With Rollers



**1713 Ottoman**

29w 19d 18h  
 Standard With Dressmaker Skirt  
 Standard With Rollers





### 1731 Ottoman

29w 22d 17h  
 Standard With Brass Ferrules  
 Standard With Brass Casters  
 Finish Shown: Antique Fruitwood



### 1732 Ottoman

31w 19d 19h  
 Standard With Kick Pleat Skirt  
 Standard With Rollers



### 1745 Ottoman

35w 26d 16h  
 Standard With Kick Pleat Skirt  
 Standard With Rollers



### 1755-O Ottoman

31w 22d 17h  
 Finish Shown: Carob Brown



Also Available:

### 1755-O-D Ottoman

With Dressmaker Skirt



### 1735-O Ottoman

29w 22d 18h  
 Finish Shown: Carob Brown  
 Standard Nail: #3-FN Spaced



### 1735-O-N Ottoman

29w 22d 18h  
 Finish Shown: Carob Brown



1735-N Chair

Coordinates With 1735-O-N Ottoman



### 1769 Ottoman

27w 20d 18h  
 Standard With Brass Ferrules  
 Finish Shown: Carob Brown  
 Standard Nail: #1-FN







### 1779 Ottoman

29w 19D 17H  
Standard With Rollers



### 1781 Ottoman

34w 25D 19H  
Standard With Kick Pleat Skirt  
Standard With Rollers



### 1812 Ottoman

42w 26D 20H  
Standard With Kick Pleat Skirt  
Standard With Rollers



### 1879 Ottoman

27w 20D 18H  
Finish Shown: Modern Elm



### 1786-O Ottoman

28w 22D 17H  
Finish Shown: Ebony



### 1790 Ottoman

34w 25D 18H  
Standard With Rollers  
Standard Nail: #4-N Spaced



### 2365 Ottoman

26w 21D 17H  
Standard Nail: #1-BZ, #3-BZ Spaced  
Finish Shown: Carob Brown



### 3318 Ottoman

26w 20D 18H  
Finish Shown: Modern Elm







**3969 Ottoman**

27w 20d 18h  
 Standard With Brass Ferrules  
 Finish Shown: Antique Walnut



**5500 Ottoman**

21w 21d 18h  
 Standard With Rollers



5907 Center Ottoman  
 5906 End Ottoman (2)



**5808 Bench**

27w 21d 23h  
 Standard Nail: #1-BB  
 Shown With #1-FN Nail Trim



**5901 Ottoman**

22w 22d 18h

**5907 Center Ottoman**

31w 28d 19h  
 Skirt Height: 9 1/4  
 Roller Casters Optional  
 Standard With Kick Pleat Skirt



**5906 End Ottoman**

(Two Shown)  
 17w 28d 19h  
 Skirt Height: 9 1/4  
 Roller Casters Optional  
 Standard With Kick Pleat Skirt

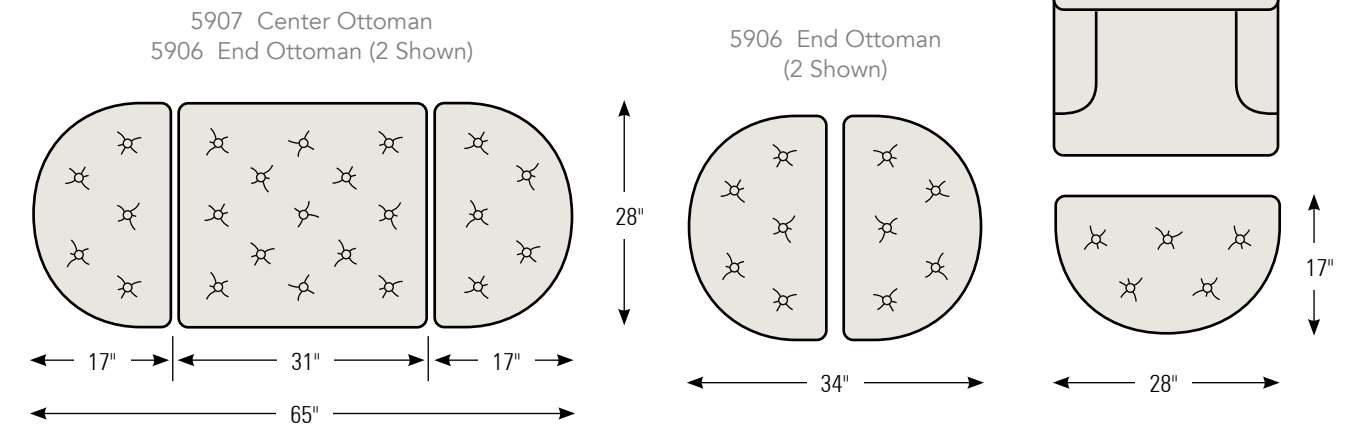





**5916 Ottoman**

49w 24D 17H  
Finish Shown: Antique Fruitwood



**5919 Ottoman**

30w 30D 18H  
Standard With Rollers  
Standard Nail: #4-OX Spaced



**6026 Ottoman**

18w 18D 20H



**6027 Ottoman**

18w 18D 18H  
Finish Shown: Ebony



**5993 Ottoman**

23w 23D 21H  
Standard Nail: #1-P



**6008 Ottoman**

21w 21D 20H



**6030 Ottoman**

18w 18D 18H  
Standard With Kick Pleat Skirt



**6033 Ottoman**

18w 18D 18H







**6049 Ottoman**

41w 41d 19h  
 Standard Nail: #1-BZ, #4-BZ Spaced  
 Standard With Recessed Wood Feet



**6060 Ottoman**

34w 34d 17h  
 Standard With Rollers  
 Standard Nail: #4-N Spaced



**6177 Storage Ottoman**

47w 47d 19h  
 Seat Height: 19  
 Finish Shown: Carob Brown  
 Opens For Storage



**F438-00 Ottoman**

26w 21d 17h  
 Standard With Casters  
 Standard Nail: #1-FN Head To Head  
 Shown With Option Nail: #4-FN Spaced















































6049 Ottoman  
 MH19326 Cyma Reverse Table  
 8900-06 Whittemore Sherrill Sofa

























## Upholstery Nail Trim

Finish	Size	#0	#1	#2	#3	#4
A-ANTIQUE						
		#0-A	#1-A	#2-A	#3-A	#4-A
AB-ANTIQUE BLACK						
		#0-AB	#1-AB	#2-AB	#3-AB	#4-AB
BB-BRIGHT BRASS						
		#0-BB	#1-BB	#2-BB	#3-BB	#4-BB
BZ-BRONZE						
		#0-BZ	#1-BZ	#2-BZ	#3-BZ	#4-BZ
FN-FRENCH NATURAL						
		#0-FN	#1-FN	#2-FN	#3-FN	#4-FN
G-GOLD						
		#0-G	#1-G	#2-G	#3-G	#4-G
GM-GUN METAL						
		#0-GM	#1-GM	#2-GM	#3-GM	#4-GM
N-NATURAL						
		#0-N	#1-N	#2-N	#3-N	#4-N
NN-BLACK NICKEL						
		#0-NN	#1-NN	#2-NN	#3-NN	#4-NN

**Note:** The #0 nail is only available spaced.

## Upholstery Nail Trim

Finish	Size	#0	#1	#2	#3	#4
OB-OLD BRASS						
		#0-OB	#1-OB	#2-OB	#3-OB	#4-OB
OX-OXFORD						
		#0-OX	#1-OX	#2-OX	#3-OX	#4-OX
P-PLATINUM						
		#0-P	#1-P	#2-P	#3-P	#4-P
PN-POLISHED NICKEL						
		#0-PN	#1-PN	#2-PN	#3-PN	#4-PN
V-VINTAGE						
		#0-V	#1-V	#2-V	#3-V	#4-V

Note: Colors shown may vary from actual nail finishes due to printing process.  
 Nails pictured here are not actual size. Actual nail sizes are:  
 #0 = approx. 5/16"      #2 = approx. 5/8"      #4 = approx. 1"  
 #1 = approx. 1/2"      #3 = approx. 3/4"

2361 SOFA  
 Shown with optional #1N & 3N nails in place of standard.





## Sherrill Nail Trim Pricing And Options

Styles standard with nails are photographed in the catalog with the standard nails. The standard nail (size/finish) is indicated next to the image as well as any optional nails. If you would like to add nails to any frame that can accept nails please specify the nail (size/finish) and indicate exactly where nails are to be applied. The pricing listed below is for adding a row of head to head nails to the areas indicated. Any nails applied in a SPACED manner require an additional upcharge. You can change the size of the standard nail for the upcharges listed below (if available). Changing the standard nail finish is no-charge as long as you stay with the standard nail size. Any combination of special requests not covered below might be possible and should be referred to customer service.

### Pricing For Adding Decorative Nails

SELECTED AREAS	SOFA	LOVESEAT	CHAIR	OTTOMAN
ALL AROUND BASE	\$ _____	\$ _____	\$ _____	\$ _____
FRONT ARM PANELS	\$ _____	\$ _____	\$ _____	\$ _____
ALL OVER (where applicable)	\$ _____	\$ _____	\$ _____	\$ _____

#### NAIL CHANGE and Special Application pricing

CHANGE STANDARD NAIL SIZE: \$ \_\_\_\_\_

CHANGE STANDARD NAIL FINISH: N/C (changing std. nail finish is no charge as long as you stay with the std. nail size.)

Applying nails in a Spaced Manner requires an additional \$ \_\_\_\_\_ upcharge.

Applying nails spaced over Applied

Cut Tape around base: Sofa: \$ \_\_\_\_\_, Loveseat: \$ \_\_\_\_\_, Chair: \$ \_\_\_\_\_, Ottoman: \$ \_\_\_\_\_

### Sherrill Nail Assortment

Sherrill has reconfigured the nail assortment, now offering 5 nail sizes available in 13 different finishes.

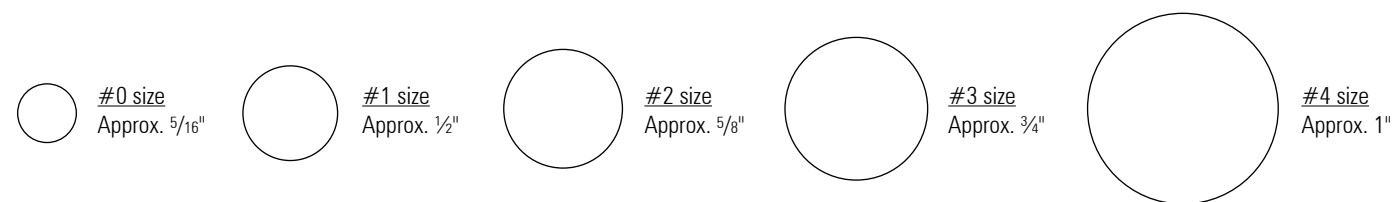

HEAD TO HEAD APPLICATION  
Note: Nail illustrations are approx. size only

SPACED APPLICATION (UP CHARGE)



6049 OTTOMAN  
Standard Nail: #1-BZ & #4-BZ  
Shown With Optional Tape Around Base



# Custom Line Wood Finishes

All Sherrill finishes are now available and interchangeable on any Sherrill item that takes a custom finish.



ANTIQUE FRUITWOOD



ANTIQUE PECAN



ANTIQUE WALNUT



ASPEN



BARLEY



BISTRO

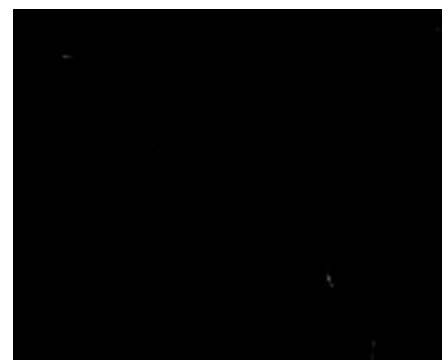

BLACK



BLACK NICKEL



BONE



BRITTANY



BROWN MAHOGANY



BURNISHED ANTIQUE

# Custom Line Wood Finishes Continued



CAFÉ



CAMBRIDGE



CAROB BROWN



CHARLTON

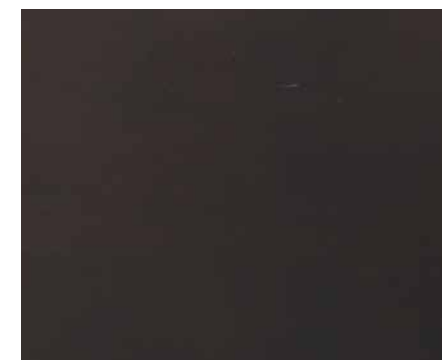

COFFEE



DUSK



EBONY



ETON



GRANITE



GREYSTONE



GUILD

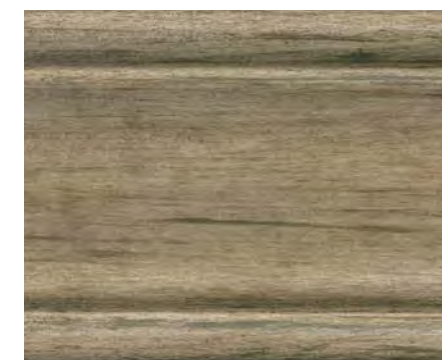

HEMP

Colors shown may vary from actual finishes due to printing process.



# Custom Line Wood Finishes Continued

All Sherrill finishes are now available and interchangeable on any Sherrill item that takes a custom finish.



LINEN



MAHOGANY



MALABAR



MINK



MODERN ELM



NORMANDY



NUTMEG



SILVER FOX



SLATE

# Custom Line Wood Finishes Continued



STONE



SUGAR



WINCHESTER



SOHO

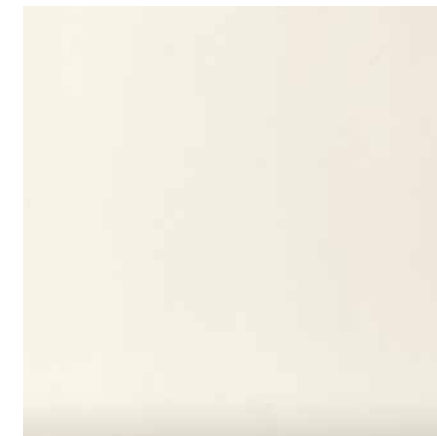

WINTER WHITE



1119 CHAIR  
1118 OTTOMAN  
Finish Shown: Nutmeg

Nutmeg finish is standard on all carved chairs. It is also available on any Sherrill style that can be done in a custom finish.

Colors shown may vary from actual finishes due to printing process.



## Order Form

STYLE: \_\_\_\_\_ LIST MAIN FABRIC THEN LIST CONTRAST FABRIC OR LEATHER BELOW

MAIN FABRIC: \_\_\_\_\_

1	Outside Back (L) _____	11	SEAT CUSHION (ENTIRE) _____
			# CUSHION PARTS _____
2	Tight Back (L) _____		# cushion top _____
3	Inside Back (L) _____ (Behind Back Cushions)		# cushion bottom _____
4	Inside Arm (L) _____		# cushion border _____
5	Outside Arm (L) _____		# cushion welt (L) / trim _____
6	Arm Panel (L) _____	12	BACK CUSHION (ENTIRE) _____
7	Top Arm (L) _____		# CUSHION PARTS _____
8	Seat (L) _____		# cushion front _____
9	Seat Border (L) _____		# cushion back _____
10	Tight Seat (L) _____		# cushion border _____
	_____ (L) _____		# cushion welt (L) / trim _____
	(OTHER)		WELT _____

13	MULTI-PILLOW BACKS ENTIRE / (FRONT SIDE) QTN / SIZE	BACK SIDE	WELT (L) / TRIM
	_____/_____/_____ / _____/_____ / _____		
	_____/_____/_____ / _____/_____ / _____		
	_____/_____/_____ / _____/_____ / _____		

14	THROW PILLOWS ENTIRE / (FRONT SIDE) QTN / SIZE	BACK SIDE	WELT (L) / TRIM
	_____/_____/_____ / _____/_____ / _____		
	_____/_____/_____ / _____/_____ / _____		
	_____/_____/_____ / _____/_____ / _____		

LEATHER:  
LIST LEATHER PARTS: \_\_\_\_\_

(L) = PARTS AVAILABLE IN CONTRASTING LEATHER  
# = NOT NECESSARY TO LIST ALL CUSHION PARTS IF ENTIRE CUSHION IS IN ONE FABRIC  
Please attach to order.

## Seat Cushion Types

Sherrill has five primary seat cushion types that are available on most styles. The SUD seat cushion is standard with all others being available as options. Each cushion style is designed to address alternative firmnesses as well as levels of tailoring.



**SUPER U-D** seat cushions are high crown urethane core with polyester fibers encased in ticking.



**SPRING-DOWN** is a Marshall Spring unit enclosed in a urethane core wrapped with polyester fibers and 25/75 feather down encased in a down proof ticking.



**ULTRA FIBER-DOWN** seat cushion is an Ultra-cell foam core wrapped into a down proof ticking of ultra down filling which is a blending of down, feathers and polyester fibers.



**COMFORT FIBER** seat cores are encased in a down proof ticking with Ultra-cell foam wrapped in a thick blanket of polyester fiber.



**COMFORT DOWN** seat cushions are a urethane core wrapped with polyester fibers and feather down encased in a down proof ticking.

Firm & Tailored

Soft & Relaxed

### Back Pillows

"Fiber Down" back pillows are a combination of premium polyester fibers with 25/75 feather down. "Shertrel" back pillows are a combination of premium polyester fibers selected for utmost comfort. All Loose Pillow Back standard with Shertrel unless otherwise stated in Price List.

\* Throw Pillows are standard with 90/10 feather down.



# Sleeper Mechanism & Mattress Specifications



## MECHANISM

- **Double Locking TV Headrest** – provides added comfort while lounging or watching TV by raising the upper body.
- **All Tubular Frame Construction & Dual One Piece Tubular legs** – provide enhanced stability and strength by allowing the unit to be operated from the center and side position.
- **Extended Deck Coverage** – the polypropylene decking is designed to extend beyond the metal frame and linkage parts eliminating any metal to upholstery contact.
- **Seat Support Wires** – provides support while sleeping, plus adding durability to the overall unit. Support wires also give the quality feel of stationary seating.



## MATTRESS

5" Interspring mattress is standard.  
 Air Dream mattress is available for an upcharge.  
 + indicates styles available with optional Air Dream mattress.  
 Queen size mattress 60" x 73" – standard in sleep sofas.  
 Twin size mattress 40" x 73" – standard in sleep loveseats.

KINGSDOWN's exclusive SLEEP IN MATTRESS INNER ROLL construction makes this the ideal innerspring mattress made for sleep sofa use. The Kingsdown Sleep In Mattress is the standard by which others are judged.

1. **Luxurious comfort** – cover is INNER ROLL quilted to thick layer of Kingsdown quality foam.
2. **Allergy Free** – Exclusive Flexatron is a blend of all man made fibers, thermally bonded in an oven at over 400°F providing an environmentally friendly and hypoallergenic padding material.
3. **Mildew resistant and odor free** – unlike raw cotton materials which is a natural medium for bacteria growth and retains moisture, FLEXATRON will not host mildew or odors.
4. **Longer life and more support** – inner spring units are totally oven tempered giving the units "memory". The units have resiliency which provides longer lasting performance.
5. **No coil feel** – FLEXATRON insulation is thermally bonded for permanent shaping, wrapping the inner- spring unit, hugging the edges so it can never shift, lump or bunch. This application eliminates pocketing of insulation.
6. **Improved seating comfort when used as a sofa** – Exclusive INNER ROLL construction with channel quilting prevents bunching, easier to fold flatter and store away.
7. **Environmentally friendly mattress** – engineered with all man made fibers and CFC-free foam cushion material does not produce fluorocarbons which are damaging to the environment.
8. **Securely locked cover and insulation** – Flanging and hog ringing locks cover and cushioning into place. This INNER LOK process prevents bunching and traveling.



## The Best Sleeper Mattress In The House!

Air Dream™ Ultra's core comfort element has been reinforced and improved to provide the maximum in luxurious sleeping and rugged durability, especially when it's used in a hospitality setting! The engineered features that make Air Dream™ Ultra an overnight success are easy to see and feel:

### Increased Comfort

- Sleep sofa mattresses have never been this plush - 11" of pure comfort
- Offers the same plush dimensions and luxury feel as premium mattresses
- Innovative technology combines spring coil support with a cushioning layer of air
- Air cushion layer adjusts from plush firm to supportive soft feel
- Separated air chambers distribute body weight evenly for ideal ergonomic support

### NEW Ease of Operation

- Embedded inflation/deflation mechanism makes operation one-touch simple with the easy to use hand wand
- Inflates in under a minute, and deflates even faster for quick storage

### Improved Durability

- Resilient, tempered bonnell low coils provide lasting buoyancy and support
- Accommodates standard sheets
- Available in twin, full and queen size



Quality For Living...  
 Quality For Life™



# Sherrill Construction

## Please read carefully when furnishing COM

For a COM fabric with patterns and/or less than 54" wide, please supply extra yardage as indicated below.

Fabric Width	Repeat 5"-15"	Repeat 15"-21"	Repeat 21"-29"
54"	20%	25%	30%
48-50"	30%	35%	40%
36"	105%	110%	115%

This information is intended as a guide only. There will be cases due to unusual repeats or designs of the fabric that will require additional yardage.

### Fabric Application: "Railroading" or "Up the Bolt"

Many Sherrill fabrics are cut to "Railroad" on the furniture; others are not because of the direction of the pattern in the fabric. Every fabric is swatched in the direction it will be cut for the furniture. If the fabric is cut to "Railroad" on the furniture it will state, "This Fabric Cut To Railroad." An explanation of exactly what this term means is shown below.

Fabric in "UP THE BOLT" or "REGULAR" Position  
(Note: With one seat cushion seaming is necessary on 60" loveseat.)

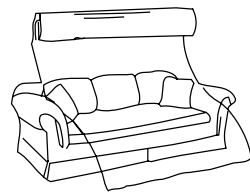

Fabric in "RAILROADED" or "TOP TO SELVAGE" Position

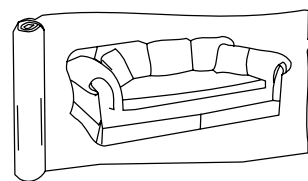

The reason for cutting those fabrics to railroad when possible is to avoid seams.

54" fabrics not "Railroaded" when applied to long cushions or narrow fabrics not "Railroaded" when applied to most cushions will require seaming. THE FACTORY WILL POSITION THESE SEAMS AT THEIR DISCRETION. If particular placement is desired, it must be stated on your order. All swatches show fabric width. Velvets normally will be applied in the REGULAR position because of the pile or nap unless we are instructed otherwise.

Unless Customer furnishes written instructions with orders as to application of fabric, our own judgement will be used in applying the fabric. Sherrill will not assume responsibility for imperfections in the fabric, dye-lot variations or wearing qualities of any COM yardage. No quality problems will be accepted on post treated fabrics, due to the mills not accepting complaints after this application.

## Sherrill Construction The Tradition Continues



NOTE: Standard construction on most styles. Subject to change without notice.



## Sherrill Construction

### Frame Construction

Sherrill blends traditional hand craftsmanship with modern manufacturing methods to produce frames that are among the finest used in the upholstery business.



1

Each frame is precisely cut and hand assembled.

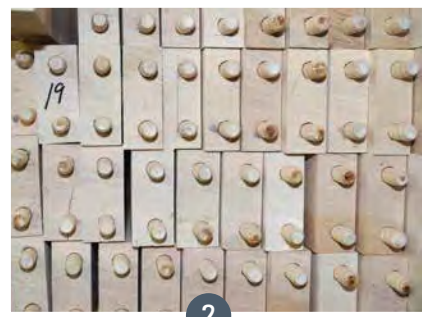

2

Double dowels are utilized in all structural parts to form sturdy, long lasting joints.

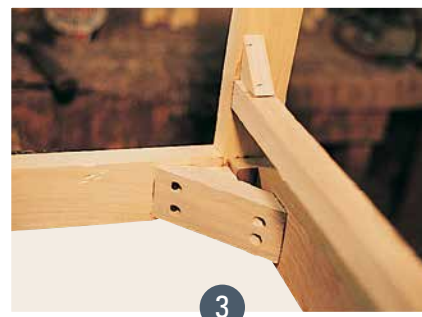

3

To complete construction and add stability to the frame, large precisely cut corner blocks are positioned at each corner where the greatest stress occurs using both glues and screws.

### Eight-Way Hand-Tied Spring System

The eight-way hand-tied system with full web bottom is characteristic of high quality furniture and is traditionally the best known technique for insuring long lasting comfort.



4

Sherrill mounts a solid interlace web bottom to each frame. Springs of various gauges and heights are securely attached to the full web bottom using clinch fasteners.



5

The individual spring coils are hand-tied and bound together in eight separate directions using polyester cording. The cording is then securely anchored to the frame.



## Sherrill Construction

### Back Construction (varies depending on style)



6

Polypropylene covering is used over the 8-way hand-tied springs and the sinuous wire spring backs as a protective shield and to provide a substantial base for various filling materials.



7

A typical Lawson style back has sinuous wire springs anchored to the frame and held together horizontally by coated wire to prevent turning.



8

Marshall units are used when thickness of back and styling permits.

### Fabrics

The Sherrill fabric line is as extensive and varied as any in the upholstery business. Sherrill stocks a complete selection of colors, patterns, weaves and yarns - all carefully selected to complement the design and craftsmanship of your new Sofa or Chair. All fabrics are carefully inspected for quality and consistency prior to being placed into stock.



Specialized cutters take particular care using individual patterns to create the proper pattern flow.



Specialized technicians perform various sewing tasks using the finest available sewing thread, sewn seven stitches to the inch to assure more durable seams and trouble free wear.



Each individual piece is cut by hand to assure that each style will exceed Sherrill's stringent tailoring standards.



## Sherrill Construction

### Filling Material

On most styles the standard filling material is urethane foam combined with polyester fibers and cotton felt.



Generous layers of polyester batting and cotton are used in conjunction with urethane foam to achieve just the right contour and comfort.

Outside arms and backs are padded to assure a smoother surface and provide an extra measure of neatness.

### Cushions

At Sherrill the standard cushion filling is U-D, a high density reinforced urethane core



Available also is Super UD filling, a high resiliency urethane with 2-1/3 ounce fiber.

Both cushions are encased in a sewn casing.

Other cushion filling options are spring-down, comfort-down and comfort-fiber.

Sherrill offers loose pillow back options fiber-down and Shertrel.

Shertrel is standard in loose backs unless otherwise stated in the price list.

When cared for properly and rotated on a regular basis Sherrill cushions will provide years of trouble free comfort.

### Upholstery

At Sherrill we are as careful applying a fabric as you are selecting one for your home. Each piece is painstakingly hand-tailored by specialized technicians who have spent years perfecting their trade.



## Custom Options

### Inspection

Sherrill's higher standard of quality is assured by thorough inspections throughout the manufacturing process. Skilled inspectors inspect frame, fabric, cutting, sewing and upholstery. After a final inspector carefully checks each piece one more time, Sherrill seals in the quality by custom packing each piece prior to shipping.



### Fabric Options: Mitered & Box Mitered

This option is available on ottoman tops and throw pillows.



Ottoman with a mitered top.



Ottoman with a box mitered top.

### General Information

All graded prices include U-D seat cushions. Standard loose pillow back filling is Shertrel unless otherwise stated in price list. Specify on your order the type seat and back filling if other than standard is desired (\* i.e. Super U-D Seat Cushions, U-D Back). Skirts are included in graded prices as indicated. Arm caps are standard. Specify all extras when ordering.

**QUILTED FABRICS:** Our standard quilt includes all inside areas quilted; outside areas and skirts are unquilted. Skirts are not available quilted.

**ALL OVER QUILT:** All areas quilted except skirt and welt.

The manufacturers of upholstered fabrics do not guarantee their products for wearability or colorfastness; whether "Teflon" treated or not; therefore, we cannot assume this responsibility. We, also, cannot guarantee match in color items ordered at separate times because of dye lot variations.



Throw Pillows

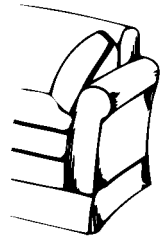

No. 1 Pillow  
14 x 13 in.  
(with Welt)

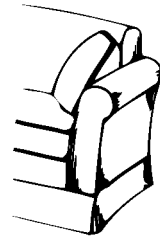

No. 3 Pillow  
15 x 15 in.  
(with Welt)



No. 8 Toss Pillow  
24 x 24 in.  
(Flanged)

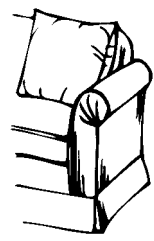

No. 9 Pillow  
18 x 18 in.  
(Weltless)

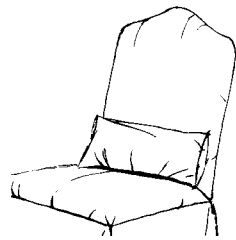

No. 10 Pillow  
20 x 11 in.  
(Kidney)

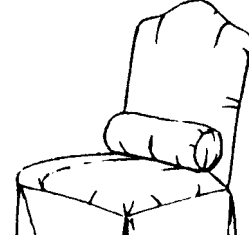

No. 12 Pillow  
8 x 20 in.  
(Cylinder)

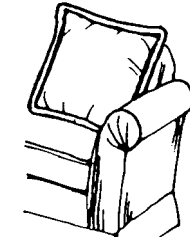

No. 15 Throw Pillow  
19 x 19 in.  
(Flanged)

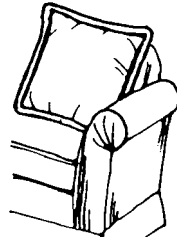

No. 16 Toss Pillow  
18 x 18 in.  
(Self-flanged)

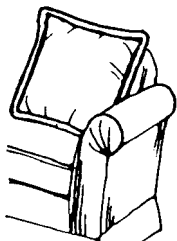

No. 17 Throw Pillow  
20 x 20 in.  
(Self-flanged)

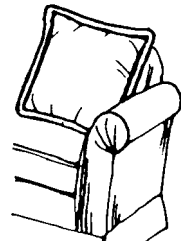

No. 18 Toss Pillow  
22 x 22 in.  
(Self-flanged)

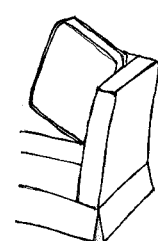

No. 19 Pillow  
22 x 22 in.  
(with Boxed Border and Welt)

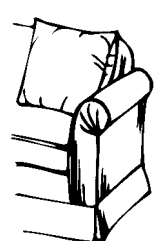

No. 20 Pillow  
18 x 18 in.  
(with Welt)



No. 25 Kidney Pillow  
14 x 21 in.  
(Flanged)

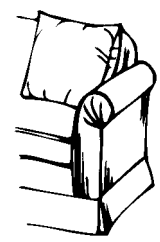

No. 30 Pillow  
20 x 20 in. (with Welt)

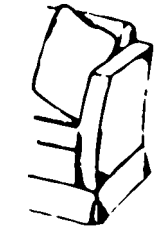

No. 40 Toss Pillow  
21 x 21 in.  
(with Welt)



No. 44 Toss Pillow  
21 x 21 in.  
(Weltless)

No. 34 Pillow  
20 x 20 in. (Weltless)

**Please Note:**  
All dimensions listed are approximate and may vary depending on fabric and construction. Specifications subject to change without notice.

Casters



ROLLER CASTER  
(Recommended  
for use with skirts)



ROYAL CASTER  
(Recommended  
for exposed use)

Skirts Available

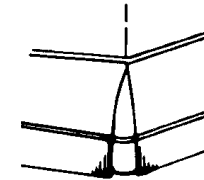

Banded Kick Pleat

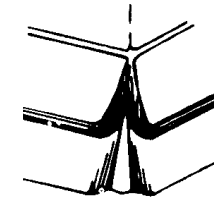

Overlay Kick Pleat

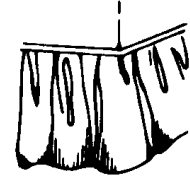

Gathered Skirt

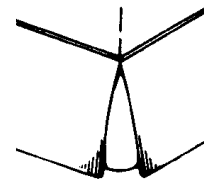

Kick Pleat

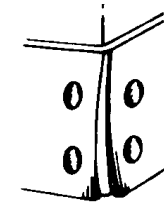

Button Pleat

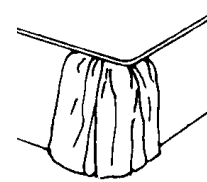

Ruffled Corner Kick Pleat

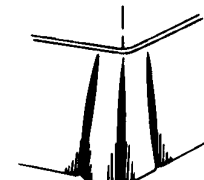

Double Corner Kick Pleat



## INDEX BY NUMBER

W10 Chair .....	Page 174
1014-1 Chair .....	Page 216
1015-1 Chair.....	Page 174
1029 Chair.....	Page 216
1034 Chair.....	Page 216
1059 Chair.....	Page 216
1108 Chair .....	Page 217
1118 Ottoman.....	Page 217, 224
F118-01 Chair .....	Page 174
1119 Chair .....	Page 217
1146 Chair .....	Page 217
F1262-01 Chair.....	Page 174
1284-1 Chair.....	Page 175
1306-1 Chair.....	Page 175
1313 Chair.....	Page 176
1315 Chair.....	Page 176
1319 Chair.....	Page 176
SW1321 Swivel Chair .....	Page 200
1329 Chair.....	Page 177
SWR1330 Swivel Rocker.....	Page 200
1332 Ottoman .....	Page 225
1338 Chair.....	Page 177
1339 Ottoman .....	Page 225
1346 Chair.....	Page 177
1347 Ottoman.....	Page 225

## INDEX BY NUMBER

1351 Chair.....	Page 210
1363 Chair.....	Page 210
1378 Ottoman .....	Page 225
138-0 Ottoman .....	Page 224
139-0 Ottoman .....	Page 224
SW1409 Swivel Chair .....	Page 200
SW1409-P Swivel Chair .....	Page 200
1413 Ottoman .....	Page 226
1424 Chair.....	Page 177
SW1425 Swivel Chair .....	Page 201
1427 Chair.....	Page 179
1435 Chair.....	Page 179
1440-1 Chair.....	Page 179
1449-1 Chair.....	Page 179
1450 Chair.....	Page 180
1451 Lounge Chair .....	Page 180
1452 Chair.....	Page 180
1455-1 Chair .....	Page 212
148-0 Ottoman .....	Page 224
MSW1502-1 Motion Swivel Chair .....	Page 206
1505-0 Bench.....	Page 212, 226
1507-1 Chair.....	Page 180
1510-1 Chair.....	Page 212
1517-1 Chair .....	Page 212
1523-0 Ottoman .....	Page 226



## INDEX BY NUMBER

1524-1 Chair .....	Page 181
SWR1527-1 Swivel Rocker .....	Page 201
1529-1 Chair .....	Page 181
1534-1 Chair .....	Page 181
1536-1 Chair .....	Page 181
1542-1 Chair .....	Page 182
1544-1 Chair .....	Page 182
1551-1 Chair .....	Page 213
1555-1 Chair .....	Page 182
F1557-03 Sofa .....	Page 24
F1557-06 Sofa .....	Page 24
1557-1 Chair .....	Page 182
F1558-01 Chair .....	Page 183
F1558-03 Sofa .....	Page 24
1565-0 Ottoman .....	Page 226
F1568-01 Chair .....	Page 183
F1568-03 Sofa .....	Page 25
1570-0 Ottoman .....	Page 227
1575-0 Ottoman.....	Page 181, 227
1578-1 Chair .....	Page 183
MSW1579-1 Motion Swivel Chair .....	Page 207
1580-1 Chair .....	Page 183
1581-1 Chair .....	Page 184
1586-1 Chair .....	Page 184
1591 Ottoman .....	Page 227

## INDEX BY NUMBER

1596-1 Chair .....	Page 184
1600 Chair .....	Page 210
SW1619 Swivel Chair .....	Page 201
1632 Chair.....	Page 185
1633 Chair.....	Page 185
1634 Chair.....	Page 184
1635 Chair.....	Page 186
1638 Chair.....	Page 210
1660 Chair.....	Page 211
MSW1660 Motion Swivel Chair .....	Page 207
F1660-01 Chair.....	Page 186
F1660-03 Sofa .....	Page 25
F1670-01 Chair.....	Page 211
F1688-01 Chair.....	Page 211
1704-1 Chair .....	Page 213
1713 Ottoman .....	Page 227
SW1714 Swivel Chair .....	Page 201
SW1715 Swivel Chair .....	Page 202
1718 Chair .....	Page 186
1719 Chair.....	Page 186
1720 Chair.....	Page 187
1722-1 Chair .....	Page 187
1730 Chair.....	Page 187
1731 Ottoman .....	Page 187
1731 Ottoman .....	Page 228



## INDEX BY NUMBER

1732 Ottoman .....	Page 228
F1735-03 Sofa .....	Page 25
1735 Chair .....	Page 187
1735-N Chair .....	Page 188
1735-0 Ottoman.....	Page 187, 228
1735-0-N Ottoman.....	Page 228
MSW1737 Motion Swivel Chair .....	Page 206
SWR1744 Swivel Rocker .....	Page 202
1745 Ottoman .....	Page 229
1750-1 Chair .....	Page 188
1755 Chair .....	Page 188
1755-D Chair .....	Page 188
1755-0 Ottoman.....	Page 188, 229
1755-0-D Ottoman.....	Page 188
1757-1 Chair .....	Page 190
SW1758 Swivel Chair .....	Page 202
1759-1 Chair .....	Page 190
1763 Chair .....	Page 190
1768 Chair .....	Page 190
1769 Ottoman .....	Page 190, 229
1779 Ottoman.....	Page 230
1781 Ottoman .....	Page 230
1783 Chair .....	Page 211
1785 Chair .....	Page 191
1786-0 Ottoman.....	Page 230

## INDEX BY NUMBER

1789 Chair .....	Page 191
1790 Ottoman .....	Page 191, 230
1796 Chair .....	Page 191
1812 Ottoman.....	Page 231
1819 Chair.....	Page 191
1823 Sofa .....	Page 26
1829 Sofa .....	Page 26
1852 Chair .....	Page 192
1855-0 Ottoman .....	Page 192
1855 Chair.....	Page 192
1878 Chair .....	Page 192
1879 Ottoman .....	Page 192, 231
1904 Sofa.....	Page 26
1921 Sofa.....	Page 27
1921-W Sofa .....	Page 27
1923 Sofa .....	Page 27
1923-62 Loveseat .....	Page 30
1923-62D Loveseat.....	Page 30
1923-D Sofa .....	Page 30
1926 Sofa .....	Page 31
1928 Sofa .....	Page 31
1929 Sofa .....	Page 31
1929-B Sofa .....	Page 34
1947 Chair .....	Page 192
1949 Sofa .....	Page 34



## INDEX BY NUMBER

FM1994-01 Motion Swivel Chair.....	Page 206
20 Series Sectional, 2049-2056 Sectional.....	Page 64
2019 Sofa.....	Page 34
2120 Sofa.....	Page 35
2126-B Sofa.....	Page 35
2212L Sofa.....	Page 35
2224-67 Loveseat.....	Page 36
2224-77 Sofa.....	Page 36
2224-87 Sofa.....	Page 36
2225-60 Loveseat.....	Page 38
2225-72 Sofa.....	Page 38
2225-78 Sofa.....	Page 38
2225-84 Sofa.....	Page 39
2226 Sofa.....	Page 39
2230 Sofa.....	Page 39
2232 Sofa.....	Page 40
2235-67 Loveseat.....	Page 40
2235-77 Sofa.....	Page 40
2235-87 Sofa.....	Page 40
2250 Sofa.....	Page 40
2250-B Sofa.....	Page 42
2266 Right Arm Chaise.....	Page 193
2267 Left Arm Chaise.....	Page 193
SW2342 Right Arm Swivel Chair.....	Page 203
SW2343 Left Arm Swivel Chair.....	Page 203

## INDEX BY NUMBER

2361 Sofa.....	Page 42
2364 Chair.....	Page 194
2365 Ottoman.....	Page 194, 231
2368 Sofa.....	Page 42
FS256-01 Swivel Chair.....	Page 202
2 Series Design Own.....	Page 126-137
2F11, 2T11 Chairs.....	Page 126-137
2F62, 2T62 Loveseats.....	Page 126-137
2F72, 2T72 Sofas.....	Page 126-137
2F73, 2T73 Sofas.....	Page 126-137
2F82, 2T82 Sofas.....	Page 126-137
2F83, 2T83 Sofas.....	Page 126-137
2F92, 2T92 Sofas.....	Page 126-137
2F93, 2T93 Sofas.....	Page 126-137
2 Series Sectional.....	Page 126-137
30 Series Sectional, 3081-3089, 3098-3099.....	Page 66
3061-2 Loveseat.....	Page 43
3061-3 Sofa.....	Page 43
3063-3 Sofa.....	Page 43
3066-2 Loveseat.....	Page 44
3066-3 Sofa.....	Page 44
3077-3 Sofa.....	Page 44
3078-2 Loveseat.....	Page 46
3078-3 Sofa.....	Page 46
3097-2 Loveseat.....	Page 46



## INDEX BY NUMBER

3097-3 Sofa.....	Page 47
31 Series Sectional, 3181-3199 .....	Page 66-67
3100-2 Loveseat.....	Page 47
3100-3 Sofa.....	Page 47
3100-4 Sofa.....	Page 48
3113-2 Loveseat.....	Page 48
3113-3 Sofa .....	Page 48
3113-4 Sofa .....	Page 49
3131-2 Loveseat .....	Page 49
3131-3 Sofa .....	Page 49
3136-2 Loveseat .....	Page 50
3153-2 Loveseat .....	Page 50
3153-3 Sofa.....	Page 50
3153-4 Sofa.....	Page 51
3157-2 Loveseat .....	Page 51
3157-3 Sofa.....	Page 51
3159-2 Loveseat .....	Page 52
3159-3 Sofa.....	Page 52
3164-2 Loveseat .....	Page 52
3164-3 Sofa.....	Page 52
3164-4 Sofa.....	Page 53
F322-03 Sofa .....	Page 53
3255 Sofa .....	Page 53
3317 Chair .....	Page 212
3318 Ottoman .....	Page 212, 231

## INDEX BY NUMBER

3331 Chair.....	Page 194
3340 Chair.....	Page 194
3341 Chair.....	Page 194
3344 Sofa.....	Page 56
3367L Chair.....	Page 196
3419 Sofa.....	Page 56
3421 Sofa.....	Page 56
F371-01 Chair.....	Page 196
3968 Chair.....	Page 196
3969 Ottoman.....	Page 196, 232
4021 Settee.....	Page 57
41 Series.....	Page 72-77
4100-0U Ottoman.....	Page 72-77
4101-1U Chair.....	Page 72-77
4122-3U Sofa.....	Page 72-77
4122-4U Sofa.....	Page 72-77
4133-3U Sofa.....	Page 72-77
4133-4U Sofa.....	Page 72-77
41 Series Sectional.....	Page 72-77
FM419-01 Motion Swivel Chair.....	Page 206
42 Series.....	Page 78-81
4200-D/U Ottoman.....	Page 78-81
4201-1D/U Chair.....	Page 78-81
4222-3D/U Sofa.....	Page 78-81
4233-3D/U Sofa.....	Page 78-81



## INDEX BY NUMBER

4222-4D/U Sofa .....	Page 78-81
4233-4D/U Sofa .....	Page 78-81
42 Series Sectional .....	Page 78-81
F420-01 Chair .....	Page 196
43 Series .....	Page 82-85
4300-0D/U Ottoman .....	Page 82-85
4301-1D/U Chair .....	Page 82-85
4222-3D/U Sofa .....	Page 82-85
4233-3D/U Sofa .....	Page 82-85
4222-4D/U Sofa .....	Page 82-85
4233-4D/U Sofa .....	Page 82-85
42 Series Sectional .....	Page 82-85
F438-00 Ottoman .....	Page 197, 236
F438-01 Chair .....	Page 197
44 Series .....	Page 86-89
4400-0U Ottoman .....	Page 86-89
4401-1U Chair .....	Page 86-89
4422-3U Sofa .....	Page 86-89
4433-3U Sofa .....	Page 86-89
44 Series Sectional .....	Page 86-89
45 Series .....	Page 90-93
4500-0U Ottoman .....	Page 90-93
4501-1U Chair .....	Page 90-93
4522-3U Sofa .....	Page 90-93
4533-3U Sofa .....	Page 90-93

## INDEX BY NUMBER

45 Series Sectional .....	Page 90-93
F460-03 Sofa .....	Page 57
46 Series .....	Page 96-97
4600-0U Ottoman .....	Page 96-97
4601-1U Chair .....	Page 96-97
4622-3U Sofa .....	Page 96-97
4622-4U Sofa .....	Page 96-97
4633-3U Sofa .....	Page 96-97
4633-4U Sofa .....	Page 96-97
46 Series Sectional .....	Page 96-97
F485-01 Chair .....	Page 213
5245 Sofa .....	Page 57
5259 Sofa .....	Page 60
5287 Sofa .....	Page 60
5500 Ottoman .....	Page 63, 197, 232
5501-T Chair .....	Page 63, 197
SW5501-T Swivel Chair .....	Page 63, 203
5597-T Mid-Sofa .....	Page 62
5598 Sofa .....	Page 62
5808 Bench .....	Page 232
5901 Ottoman .....	Page 232
5906 End Ottoman .....	Page 233
5907 Center Ottoman .....	Page 233
5916 Ottoman .....	Page 234
5919 Ottoman .....	Page 234



## INDEX BY NUMBER

5993 Ottoman.....	Page 234
6008 Ottoman .....	Page 234
6026 Ottoman .....	Page 235
6027 Ottoman.....	Page 235
6030 Ottoman .....	Page 235
6033 Ottoman .....	Page 235
6049 Ottoman .....	Page 236
6050 Dining Chair .....	Page 220
6052 Dining Chair.....	Page 220
6060 Ottoman .....	Page 236
6 Series Design Your Own .....	Page 140-149
60-SO-R, 60-SO-W Sectional Ottoman.....	Page 140-149
60-OT-R, 60-OT-W Ottoman .....	Page 140-149
61-62-63-01 Chairs .....	Page 140-149
61-62-63 Sofas .....	Page 140-149
61-62-63 Sectionals .....	Page 140-149
6177 Storage Ottoman .....	Page 236
9600/9700 Design Your Own Series .....	Page 98-113
96/97-00 Ottoman .....	Page 112-113
96/97-01 Chair.....	Page 112-113
96/97-02 Loveseat.....	Page 108
96/97-10 Large Ottoman.....	Page 110
96/97-11 Chair & Half.....	Page 110
96/97-23 Sofa.....	Page 106-109
96/97-24 Sofa .....	Page 106-109

## INDEX BY NUMBER

96/97-25 Sofa.....	Page 106-109
96/97-33 Sofa.....	Page 106-109
96/97-34 Sofa.....	Page 106-109
96/97-35 Sofa.....	Page 109
96/97 Sectional .....	Page 114-115
9800 Sherrill Your Way Series .....	Page 120-125
9800 Ottoman .....	Page 120-125
9801 Chair.....	Page 120-125
9842 Loveseat.....	Page 120-125
9800 Sectional.....	Page 120-125
9860 Right Arm Loveseat .....	Page 120-125
9861 Left Arm Loveseat .....	Page 120-125
9862 Right Arm Sofa .....	Page 120-125
9863 Left Arm Sofa .....	Page 120-125
9864 Right Arm Corner Sofa .....	Page 120-125
9865 Left Arm Corner Sofa .....	Page 120-125
9866 Right Arm Chaise .....	Page 120-125
9867 Left Arm Chaise.....	Page 120-125
9892 Sofa .....	Page 120-125
Design Classics Series.....	Page 150-177
SWDC992 Swivel Chair.....	Page 159
DC 2 Ottoman .....	Page 153
DC104 Ottoman .....	Page 152
DC105 Ottoman .....	Page 152
DC106 Ottoman .....	Page 152



## INDEX BY NUMBER

DC12 Bench .....	Page 152
DC19 Dining Chair .....	Page 160, 220
DC131-134 Sectional .....	Page 131-134
SWDC201 Swivel Chair .....	Page 158
DC220 Ottoman.....	Page 153
DC221 Chair .....	Page 154
DC225 Chair .....	Page 154
SWDC226 Swivel Chair .....	Page 158
DC227 Chair.....	Page 154, 157
DC228 Chair .....	Page 156
DC229 Chair .....	Page 156
DC24 Chair .....	Page 156
DC26 Chair .....	Page 156
SWDC27 Swivel Chair .....	Page 158
DC293 Sofa.....	Page 168
SWDC299 Swivel Chair .....	Page 158
DC3 Ottoman.....	Page 153
DC326 Sofa.....	Page 168
SWDC361 Swivel Chair.....	Page 159
DC362 Sofa.....	Page 168
DC366 Sofa.....	Page 169
DC370 Chair .....	Page 157
DC371 Sofa.....	Page 169
DC372 Sofa.....	Page 169
DC373 Sofa.....	Page 170

## INDEX BY NUMBER

DC374 Sofa.....	Page 170
DC375 Sofa.....	Page 170
DC376-380 Sectional .....	Page 166
DC4 Ottoman.....	Page 153
DC475 Dining Chair .....	Page 160
DC475 Dining Chair .....	Page 220
DC5 Bench.....	Page 154
DC50 Sofa .....	Page 171
DC62 Chair .....	Page 160, 221
DC65 Dining Chair .....	Page 160, 221
DC710-714 Sectional .....	Page 167
DC71 Sofa.....	Page 171
DC89 Sofa.....	Page 171
Design Classics Sectional.....	Page 162



# VISUAL INDEX



3969 Ottoman  
27w 20d 18h  
Page 232



1014-1 Chair  
27w 27d 38h  
Page 216



1015-1 Chair  
29w 28d 30h  
Page 174



1029 Chair  
30w 32d 43h  
Page 216



1034 Chair  
28w 37d 40h  
Page 216



139-O Ottoman  
18w 18d 18h  
Page 224



1413 Ottoman  
34w 26d 18h  
Page 226



1424 Chair  
28w 31d 42h  
Page 177



1427 Chair  
31w 34d 38h  
Page 179



1435 Chair  
35w 39d 43h  
Page 179



1059 Chair  
24w 28d 36h  
Page 216



1108 Chair  
30w 35d 38h  
Page 217



1118 Ottoman  
33w 25d 18h  
Page 217



1119 Chair  
33w 35d 39h  
Page 217



1146 Chair  
28w 34d 39h  
Page 217



1440-1 Chair  
32w 38d 35h  
Page 179



1449-1 Chair  
36w 35d 36h  
Page 179



1450 Chair  
33w 37d 40h  
Page 180



1451 Lounge Chair  
33w 37d 40h  
Page 180



1452 Chair  
33w 37d 40h  
Page 180



1284-1 Chair  
28w 36d 37h  
Page 175



1306-1 Chair  
28w 29d 35h  
Page 175



1313 Chair  
30w 37d 36h  
Page 176



1315 Chair  
28w 31d 33h  
Page 176



1319 Chair  
33w 35d 33h  
Page 176



1455-1 Chair  
31w 34d 45h  
Page 212



148-O Ottoman  
43w 29d 17h  
Page 224



1505-O Bench  
24w 18d 16h  
Page 212



1507-1 Chair  
33w 39d 38h  
Page 180



1510-1 Chair  
32w 35d 43h  
Page 212



1329 Chair  
37w 40d 38h  
Page 177



1332 Ottoman  
28w 22d 17h  
Page 225



1338 Chair  
36w 38d 38h  
Page 177



1339 Ottoman  
27w 21d 18h  
Page 225



1346 Chair  
30w 37d 39h  
Page 177



1517-1 Chair  
33w 34d 45h  
Page 212



1523-O Ottoman  
25w 21d 15h  
Page 226



1524-1 Chair  
30w 34d 38h  
Page 181



1529-1-NS Chair  
37w 38d 36h  
Page 181



1534-1 Chair  
30w 36d 37h  
Page 181



1347 Ottoman  
26w 20d 17h  
Page 225



1351 Chair  
33w 36d 43h  
Page 210



1363 Chair  
29w 36d 42h  
Page 210



1378 Ottoman  
27w 21d 18h  
Page 225



138-O Ottoman  
43w 28d 17h  
Page 224



1536-1 Chair  
33w 37d 36h  
Page 181



1542-1 Chair  
29w 36d 38h  
Page 182



1544-1 Chair  
34w 36d 39h  
Page 182



1551-1 Chair  
29w 34d 44h  
Page 213



1555-1 Chair  
29w 32d 36h  
Page 182

# VISUAL INDEX



# VISUAL INDEX



1557-1 Chair  
29w 36D 37H  
Page 182



1565-O Ottoman  
25w 21D 15H  
Page 226



1570-O Ottoman  
27w 21D 17H  
Page 227



1575-O Ottoman  
26w 22D 15H  
Page 181



1578-1 Chair  
30w 36D 36H  
Page 183



1731 Ottoman  
29w 22D 17H  
Page 187



1732 Ottoman  
31w 19D 19H  
Page 228



1735 Chair  
34w 39D 40H  
Page 187



1735-N Chair  
34w 39D 40H  
Page 188



1735-O Ottoman  
29w 22D 18H  
Page 187



1580-1 Chair  
29w 31D 31H  
Page 183



1581-1 Chair  
32w 33D 38H  
Page 184



1586-1 Chair  
29w 35D 39H  
Page 184



1591 Ottoman  
34w 25D 18H  
Page 227



1596-1 Chair  
30w 36D 36H  
Page 184



1735-O-N Ottoman  
29w 22D 18H  
Page 228



1745 Ottoman  
35w 26D 16H  
Page 229



1750-1 Chair  
29w 38D 37H  
Page 188



1755 Chair  
35w 39D 37H  
Page 188



1755-D Chair  
35w 39D 37H  
Page 188



1600 Chair  
31w 36D 44H  
Page 210



1632 Chair  
25w 30D 36H  
Page 185



1633 Chair  
28w 32D 36H  
Page 185



1634 Chair  
25w 30D 30H  
Page 184



1635 Chair  
31w 33D 31H  
Page 186



1755-O Ottoman  
31w 22D 17H  
Page 188



1757-1 Chair  
34w 36D 39H  
Page 190



1759-1 Chair  
33w 37D 37H  
Page 190



1763 Chair  
31w 34D 38H  
Page 190



1768 Chair  
31w 40D 37H  
Page 190



1638 Chair  
30w 35D 45H  
Page 210



1660 Chair  
30w 38D 50H  
Page 211



F1688-01 Chair  
29w 38D 40H  
Page 211



1704-1 Chair  
30w 37D 38H  
Page 213



1713 Ottoman  
29w 19D 18H  
Page 227



1769 Ottoman  
27w 20D 18H  
Page 190



1779 Ottoman  
29w 19D 17H  
Page 230



1781 Ottoman  
34w 25D 19H  
Page 230



1783 Chair  
33w 36D 40H  
Page 211



1785 Chair  
31w 37D 40H  
Page 191



1718 Chair  
32w 38D 37H  
Page 186



1719 Chair  
33w 38D 33H  
Page 186



1720 Chair  
31w 38D 39H  
Page 187



1722-1 Chair  
33w 37D 37H  
Page 187



1730 Chair  
41w 41D 40H  
Page 187



1786-O Ottoman  
28w 22D 17H  
Page 230



1789 Chair  
41w 44D 41H  
Page 191



1790 Ottoman  
34w 25D 18H  
Page 191, 230



1796 Chair  
33w 35D 43H  
Page 191



1812 Ottoman  
42w 26D 20H  
Page 231

# VISUAL INDEX



# VISUAL INDEX



1819 Chair  
33w 39d 36h  
Page 191



1823 Sofa  
91w 39d 37h  
Page 26



1829 Sofa  
88w 38d 36h  
Page 26



1852 Chair  
34w 39d 40h  
Page 192



1855 Chair  
35w 39d 37h  
Page 192



2225-60 Loveseat  
60w 35d 35h  
Page 38



2225-72 Sofa  
72w 35d 35h  
Page 38



2225-78 Sofa  
78w 35d 35h  
Page 38



2225-84 Sofa  
84w 35d 35h  
Page 39



2226 Sofa  
88w 42d 41h  
Page 39



1878 Chair  
31w 40d 37h  
Page 192



1879 Ottoman  
27w 20d 18h  
Page 192



1904 Sofa  
85w 34d 38h  
Page 26



1921 Sofa  
88w 40d 36h  
Page 27



1921-W Sofa  
88w 40d 36h  
Page 27



2230 Sofa  
98w 46d 38h  
Page 39



2232 Sofa  
99w 44d 41h  
Page 40



2235-87 Sofa  
87w 41d 38h  
Page 40



2250 Sofa  
90w 40d 40h  
Page 40



2250-B Sofa  
90w 40d 40h  
Page 42



1923 Sofa  
91w 39d 37h  
Page 27



1923-62 Loveseat  
62w 39d 37h  
Page 30



1923-62D Loveseat  
62w 39d 37h  
Page 30



1923-D Sofa  
91w 39d 37h  
Page 30



1926 Sofa  
85w 34d 38h  
Page 31



2266 Right Arm Chaise  
70w 32d 41h  
Page 193



2267 Left Arm Chaise  
70w 32d 41h  
Page 193



2361 Sofa  
89w 40d 38h  
Page 42



2364 Chair  
38w 41d 38h  
Page 194



2365 Ottoman  
28w 21d 17h  
Page 194



1928 Sofa  
85w 35d 38h  
Page 31



1929 Sofa  
88w 38d 36h  
Page 31



1929-B Sofa  
88w 38d 36h  
Page 34



1947 Chair  
32w 38d 38h  
Page 192



1949 Sofa  
81w 38d 38h  
Page 34



2368 Sofa  
95w 42d 39h  
Page 42



20 Series Sectional  
Page 64



2 Design Your Own Series  
Page 128



2F11-NBAT Chair  
36w 35od 20sd 36h  
Page 132



2F11-RBLS Chair  
36w 35od 20sd 36h  
Page 132



2019 Sofa  
100w 37d 34h  
Page 34



2120 Sofa  
93w 37d 33h  
Page 35



2126-B Sofa  
94w 41d 37h  
Page 35



2212L Sofa  
72w 37d 35h  
Page 35



2224-87 Sofa  
87w 39d 41h  
Page 36



2F11-SCLD Chair  
36w 20od 20sd 36h  
Page 132



2F11TCLT  
30w 35d 36h  
Page 137



2F72-PBLT 72" Sofa  
72w 35od 20sd 36h  
Page 133



2F72SBLT  
72w 35d 36h  
Page 137



2F72SCLD  
35w 35d 36h  
Page 137

# VISUAL INDEX



# VISUAL INDEX



2F82-TBAD 82" Two Cushion 2F82TBLT Sofa  
82/76w\* 35od 20sd 36H  
Page 133

82/76w\* 35D 36H  
Page 137

2T11-PKLD Chair  
36w 35od 20sd 36H  
Page 132

2T11RBAS  
36w 35D 36H  
Page 136

2T62-RKAS 62" Loveseat  
62w 35od 20sd 36H  
Page 133



2T62SBAT  
62w 35D 36H  
Page 136

2T72NKLS  
72w 35D 36H  
Page 136

2T93-NKLS 92" Three Cushion Sofa  
92w 35od 20sd 36H  
Page 133

2T93TBLT  
92/86w\* 35D 36H  
Page 136

2 Series Sectional  
Page 135



30 Series Sectional  
Page 66



3061-2 Loveseat  
62w 38D 37H  
Page 43



3061-3 Sofa  
84w 38D 37H  
Page 43



3063-3 Sofa  
75w 35D 37H  
Page 43



3066-2 Loveseat  
62w 38D 37H  
Page 44



3066-3 Sofa  
84w 38D 37H  
Page 44

3077-3 Sofa  
80w 36D 39H  
Page 44

3078-2 Loveseat  
58w 38D 39H  
Page 46

3078-3 Sofa  
82w 38D 39H  
Page 46

3097-2 Loveseat  
57w 38D 36H  
Page 46



3097-3 Sofa  
80w 38D 36H  
Page 47

3100-2 Loveseat  
58w 38D 37H  
Page 47

3100-3 Sofa  
80w 38D 37H  
Page 47

3100-4 Sofa  
87w 38D 37H  
Page 48

3113-2 Loveseat  
60w 34D 34H  
Page 48



3113-3 Sofa  
71w 34D 34H  
Page 48

3113-4 Sofa  
86w 34D 34H  
Page 49

3131-2 Loveseat  
62w 38D 37H  
Page 49

3131-3 Sofa  
84w 38D 37H  
Page 49

3136-2 Loveseat  
66w 36D 35H  
Page 50



3153-2 Loveseat  
60w 34D 34H  
Page 50

3153-3 Sofa  
71w 34D 34H  
Page 50

3153-4 Sofa  
88w 34D 34H  
Page 51

3157-2 Loveseat  
50w 36D 37H  
Page 51

3157-3 Sofa  
72w 36D 37H  
Page 51



3159-3 Sofa  
84w 40D 36H  
Page 52

3164-2 Loveseat  
60w 36D 31H  
Page 52

3164-3 Sofa  
83w 36D 31H  
Page 52

3164-4 Sofa  
91w 36D 31H  
Page 53

3255 Sofa  
76w 39D 35H  
Page 53



3317 Chair  
30w 38D 39H  
Page 212

3318 Ottoman  
26w 20D 18H  
Page 212

3331 Chair  
28w 37D 37H  
Page 194

3340 Chair  
32w 36D 36H  
Page 194

3341 Chair  
28w 37D 37H  
Page 194



3344 Sofa  
100w 40D 40H  
Page 56

3367L Chair  
36w 39D 39H  
Page 196

3419 Sofa  
85w 40D 36H  
Page 56

3421 Sofa  
85w 40D 36H  
Page 56

3968 Chair  
31w 40D 37H  
Page 196

# VISUAL INDEX



# VISUAL INDEX



4021 Settee  
52w 37D 42H  
Page 57



41 Series/Sectional  
Page 75



4101-1U Chair  
33w 38D 37H  
Page 74



4122-4U Sofa  
90w 38D 37H  
Page 74



4133-3U Three Cushion Sofa  
81w 38D 37H  
Page 72, 76



4601-1U Chair  
31w 36D 40H  
Page 96



4633-4U Sofa  
86w 36D 40H  
Page 96



5245 Sofa  
96w 43D 33H  
Page 57



5259 Sofa  
95w 39D 37H  
Page 60



5287 Sofa  
100w 38D 36H  
Page 60



4133-4U Sofa  
90w 38D 37H  
Page 76



41-LA3U Left Arm Sofa  
78w 38D 37H  
Page 74



41-RA1U Right Arm Chaise  
26w 48D 37H  
Page 74



42 Series/Sectional  
Page 81



4200-0U Ottoman  
27w 20D 17H  
Page 78



5500 Ottoman  
21w 21D 18H  
Page 63



5501-T Chair  
32w 33D 36H  
Page 63



5597-T Mid-Sofa  
84w 40D 35H  
Page 62



5598 Sofa  
96w 40D 35H  
Page 62



5808 Bench  
27w 21D 23H  
Page 232



4201-1U Chair  
35w 21D 37H  
Page 78



4222-3D Two Cushion Sofa  
82w 36D 37H  
Page 80



4222-4U Sofa  
90w 36D 37H  
Page 80



43 Series  
Page 83



4301-1D Chair  
31w 36D 37H  
Page 84



5901 Ottoman  
22w 22D 18H  
Page 232



5906 End Ottoman  
17w 28D 19H  
Page 233



5907 Center Ottoman  
31w 28D 19H  
Page 233



5916 Ottoman  
49w 24D 17H  
Page 234



5919 Ottoman  
30w 30D 18H  
Page 234



4322-3U Two Cushion Sofa  
78w 36D 37H  
Page 84



4322-4U Sofa  
86w 36D 37H  
Page 84



43 Series Sectional  
Page 82



44 Series/Sectional  
Page 89



4401-1U Chair  
36w 38D 36H  
Page 88



5993 Ottoman  
23w 23D 21H  
Page 234



6008 Ottoman  
21w 21D 20H  
Page 234



6026 Ottoman  
18w 18D 20H  
Page 235



6027 Ottoman  
18w 18D 18H  
Page 235



6030 Ottoman  
18w 18D 18H  
Page 235



4422-3U Two Cushion Sofa  
83w 38D 36H  
Page 88



45 Series/Sectional  
Page 93



4501-1U Chair  
36w 38D 37H  
Page 92



4533-3U Sofa  
80w 38D 37H  
Page 92



46 Series Sectional  
Page 97



6033 Ottoman  
18w 18D 18H  
Page 235



6049 Ottoman  
41w 41D 19H  
Page 236



6050 Dining Chair  
21w 24D 41H  
Page 220



6052 Dining Chair  
21w 27D 44H  
Page 220



6060 Ottoman  
34w 34D 17H  
Page 236

# VISUAL INDEX



# VISUAL INDEX



6 Design Your Own Series  
Page 140



60-OTR Ottoman  
30w 30d 17h  
Page 142



6101 Chair  
46w 41d 36h  
Page 142



6121-86 Sofa  
86w 41d 36h  
Page 144



6131-06 Sofa  
106w 41d 36h  
Page 144



6133-06 Sofa  
106w 41d 36h  
Page 144



6177 Storage Ottoman  
47w 47d 19h  
Page 236



6201 Chair  
46w 41d 36h  
Page 142



6221-06 Sofa  
106w 41d 36h  
Page 145



6231-96 Sofa  
96w 41d 36h  
Page 145



6233-96 Sofa  
96w 41d 36h  
Page 145



6301 Chair  
46w 41d 36h  
Page 142



6321-96 Sofa  
96w 41d 36h  
Page 146



6322-06 Sofa  
106w 41d 36h  
Page 146



6331-86 Sofa  
86w 41d 36h  
Page 146



96/97 Design Your Own Series/Sectionals  
Page 114



9601-AFBD Chair  
40w 24d 39h  
Page 113



9601-BSCD Chair  
33w 22d 37h  
Page 111



9601-CFLT Chair  
33w 22d 35h  
Page 111



9601-EFKD Chair  
33w 22d 37h  
Page 112



9601-KFAL Chair  
33w 22d 37h  
Page 112



9601-NFLH Chair  
33w 22d 35h  
Page 111



9623-FFCU Two Cushion 80" Sofa  
80w 22d 37h  
Page 106



9623-MFCU Two Cushion 80" Sofa  
80w 22d 37h  
Page 106



9623-NLT Two Cushion 80" Sofa  
80w 22d 35h  
Page 106



9623-PSD Two Cushion 80" Sofa  
80w 22d 37h  
Page 106



9624-KSLT Two Cushion 88" Sofa  
88w 22d 37h  
Page 107



9624-NFSH Two Cushion 88" Sofa  
88w 22d 37h  
Page 107



9634-RBS Three Cushion 88" Sofa  
88w 22d 37h  
Page 107



9700-XXS Ottoman  
30w 19d 17h  
Page 113



9701-FSCT Chair  
33w 24d 39h  
Page 112



9701-LFAL Chair  
33w 24d 39h  
Page 112



9701-MSBD Chair  
33w 24d 39h  
Page 113



9701-PKS Chair  
40w 24d 39h  
Page 113



9701-SFTU Chair  
40w 24d 39h  
Page 113



9702-PFBS Loveseat  
66w 24d 39h  
Page 108



9723-NFLH Two Cushion 80" Sofa  
37h 80w 24d  
Page 108



9724-CFAU Two Cushion 88" Sofa  
88w 24d 39h  
Page 107



9725-WBSL Two Cushion 97" Sofa  
39h 97w 24d  
Page 109



9733-SBT Three Cushion 80" Sofa  
39h 80w 24d  
Page 108



9734-BFCD Three Cushion 88" Sofa  
39h 88w 24d  
Page 108



9734-EFKB Three Cushion 88" Sofa  
39h 88w 24d  
Page 109



9734-LFBH Three Cushion 88" Sofa  
39h 88w 24d  
Page 109



9734-NFBH Three Cushion 88" Sofa  
88w 24d 39h  
Page 109



9800 Series/Sectional  
Page 121



9800 Ottoman  
18w 34d 25h  
Page 125



9800-NS Ottoman  
34w 25d 18h  
Page 120



9801-E (NS) Chair  
48w 42d 39h  
Page 124



9801-P Chair  
48w 42d 39h  
Page 125



9801-T (NS) Chair  
48w 23d 39h  
Page 120

# VISUAL INDEX



# VISUAL INDEX



9842-R (NS)  
Loveseat  
66w 42d 39h  
Page 123



9863-R Left Arm  
Sofa  
84w 42d 39h  
Page 125



9863-T (NS) Left Arm  
Sofa  
84w 42d 39h  
Page 124



9864-T (NS) Right  
Arm Corner Sofa  
98w 42d 39h  
Page 124



9866-R Right Arm  
Chaise  
34w 68d 39h  
Page 125



9892-R (NS) Sofa  
92w 42d 39h  
Page 123



9892-R Sofa  
92w 42d 39h  
Page 123



9892-S Sofa  
92w 42d 39h  
Page 125



9892-T (NS) Sofa  
92w 42d 39h  
Page 124



Design Classics  
Page 151



DC 2 Ottoman  
24w 21d 20h  
Page 153



DC104 Ottoman  
52w 19d 19h  
Page 152



DC105 Ottoman  
48w 48d 19h  
Page 152



DC106 Ottoman  
21w 21d 19h  
Page 152



DC12 Bench  
27w 21d 22h  
Page 152



DC131-134  
Sectional  
Page 162



DC19 Dining Chair  
21w 26d 39h  
Page 160



DC220 Ottoman  
25w 20d 19h  
Page 153



DC221 Chair  
26w 33d 33h  
Page 154



DC225 Chair  
30w 34d 37h  
Page 154



DC293 Sofa  
73w 43d 35h  
Page 168



DC3 Ottoman  
18w 18d 18h  
Page 153



DC326 Sofa  
86w 38d 37h  
Page 168



DC362 Sofa  
86w 38d 37h  
Page 168



DC366 Sofa  
93w 38d 38h  
Page 169



DC370 Chair  
34w 40d 37h  
Page 157



DC371 Sofa  
88w 38d 36h  
Page 169



DC372 Sofa  
71w 39d 36h  
Page 169



DC373 Sofa  
87w 40d 37h  
Page 170



DC374 Sofa  
94w 38d 37h  
Page 170



DC375 Sofa  
80w 38d 37h  
Page 170



DC376-380 Sectional  
Page 166



DC4 Ottoman  
23w 18d 17h  
Page 153



DC475 Dining Chair  
22w 25d 37h  
Page 160



DC5 Bench  
25w 20d 19h  
Page 154



DC50 Sofa  
74w 37d 35h  
Page 171



DC62 Chair  
21w 26d 37h  
Page 160



DC65 Dining Chair  
21w 27d 40h  
Page 160



DC71 Sofa  
82w 38d 36h  
Page 171



DC89 Sofa  
101w 37d 35h  
Page 171



DC227 Chair  
28w 35d 35h  
Page 154



DC228 Chair  
32w 35d 37h  
Page 156



DC229 Chair  
29w 35d 33h  
Page 156



DC24 Chair  
31w 38d 50h  
Page 156



DC26 Chair  
34w 38d 35h  
Page 156



DC710-714 Sectional  
Page 167



F118-01 Chair  
28w 27d 32h  
Page 174



F1262-01 Chair  
27w 32d 38h  
Page 174



F1557-03 Sofa  
72w 38d 38h  
Page 24







F1557-06 Sofa  
86w 38d 38h  
Page 24

# VISUAL INDEX



# VISUAL INDEX

				
F1558-01 Chair 36w 35D 38H Page 183	F1558-03 Sofa 92w 35D 38H Page 24	F1568-01 Chair 36w 35D 38H Page 183	F1568-03 Sofa 92w 35D 38H Page 25	F1660-01 Chair 32w 35D 36H Page 186

				
F1660-03 Sofa 87w 35D 36H Page 25	F1670-01 Chair 39w 32D 48H Page 211	F1735-03 Sofa 89w 38D 40H Page 25	F322-03 Sofa 100w 41D 32H Page 53	F371-01 Chair 31w 33D 36H Page 196

				
F420-01 Chair 30w 38D 40H Page 196	F438-00 Ottoman 26w 21D 17H Page 236	F438-01 Chair 32w 42D 39H Page 197	1855-00 Ottoman 26w 21D 17H Page 197	F460-03 Sofa 110w 43D 36H Page 57

				
F485-01 Chair 34w 36D 42H Page 213	FM1994-01 Motion Swivel Chair 28w 41D 39H Page 206	FM419-01 Motion Swivel Chair 36w 40D 40H Page 206	FS256-01 Swivel Chair 32w 38D 37H Page 202	MSW1502-1 Motion Swivel Chair 28w 34D 31H Page 206

				
MSW1579-1 Motion Swivel Chair 32w 37D 34H Page 207	MSW1660 Motion Swivel Chair 28w 33D 31H Page 207	MSW1737 Motion Swivel Chair 33w 38D 41H Page 206	SW1321 Swivel Chair 32w 30D 29H Page 200	SW1409 Swivel Chair 35w 34D 30H Page 200

# VISUAL INDEX

				
SW1409-P Swivel Chair 35w 34D 30H Page 200	SW1425 Swivel Chair 31w 31D 31H Page 201	SW1619 Swivel Chair 33w 36D 34H Page 201	SW1714 Swivel Chair 34w 39D 38H Page 201	Sw1715 Swivel Chair 35w 37D 39H Page 202

				
SW1758 Swivel Chair 36w 39D 35H Page 202	SW2342 Right Arm Swivel Chair 33w 34D 30H Page 203	SW2343 Left Arm Swivel Chair 33w 34D 30H Page 203	SW5501-T Swivel Chair 32w 33D 36H Page 63	SWDC201 Swivel Chair 35w 38D 36H Page 158

				
SWDC226 Swivel Chair 34w 38D 35H Page 158	SWDC27 Swivel Chair 33w 36D 35H Page 158	SWDC299 Swivel Chair 29w 34D 31H Page 158	SWDC361 Swivel Chair 34w 36D 35H Page 159	SWDC992 Swivel Chair 29w 34D 31H Page 159

			
SWR1330 Swivel Rocker 35w 37D 39H Page 200	SWR1527-1 Swivel Rocker 36w 38D 36H Page 201	SWR1744 Swivel Rocker 34w 39D 38H Page 202	W10 Chair 31w 35D 36H Page 174



## Product Description Key

Style Number	○ DC375 Sofa ○	Style Number
Dimensions (inches)	○ 80W 38D 37H ○	Dimensions (inches)
Dimensions (inches)	○ Inside: 64W 21D ○	Dimensions (inches)
Dimensions (inches)	○ Arm Height: 25 Seat Height: 19 ○	Dimensions (inches)
Product Details	○ Loose Pillow Back ○	Product Details
Product Details	○ Standard With Two 21" Throw Pillows ○	Product Details
Symbol Icons *See Key Below	○ Finish Shown: Carob Brown ○	Symbol Icons *See Key Below



## Symbol Key

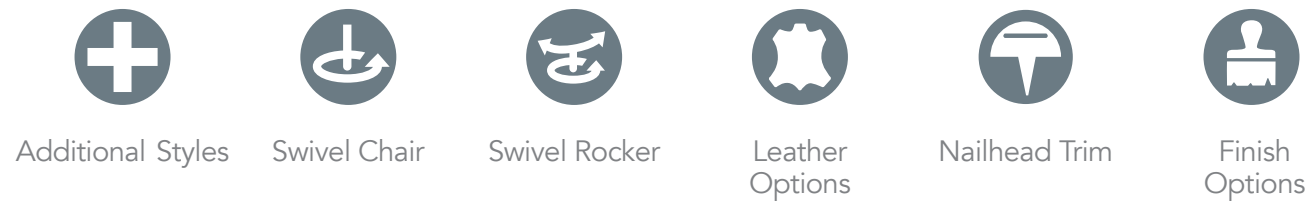

Did you know many of our best-selling frames are available in fabric *and* leather?

We have thousands of fabrics, leathers, and wood finishes to choose from! Keep an eye out for those icons underneath each product.



Available in Leather

Available in Fabric

ALL HANDMADE IN THE USA

To Stay Up To Date On All Things Sherrill Furniture, Follow Us On Instagram!

@SherrillFurnitureBrands

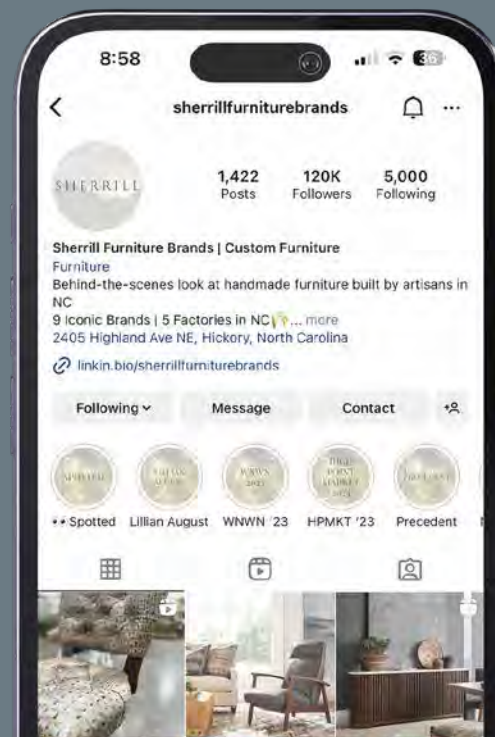

Notice the clean, neutral body fabric featured in our photos.

This clean look makes it easy to see differences in frame styles, as well as overlay fabric samples on photos.







# SHERRILL FURNITURE

## 2024 Catalog



2405 Highland Avenue NE » Hickory, North Carolina » 28601  
Phone: (828) 322-2640 » Fax: (828) 324-8207

[SherrillFurniture.com](http://SherrillFurniture.com)